

**System: Lauf- und Führungsschiene aufgeschraubt, ohne Korpusbearbeitung, für zwei Holztüren bis 40 kg. Design Flächenbündig /Forslide**

System: Running and guide track screwed on, without cabinet modification, for two wooden doors up to 40 kg. Flush design /Forslide

Système: rails de roulement et de guidage vissés, aucune préparation nécessaire le corps de meuble, pour deux portes en bois jusqu'à 40 kg. Pour deux portes en bois jusqu'à 20 kg. Design affleurant /Forslide

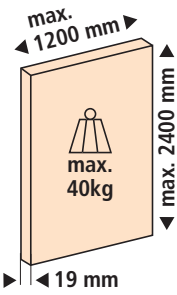

**Abkürzungen/Abbreviations/Abréviations**

<b>TH</b>	<b>Türhöhe</b>	Door height	Hauteur de porte
<b>TB</b>	<b>Türbreite</b>	Door width	Largeur de porte
<b>H</b>	<b>Höhe</b>	Height	Hauteur
<b>W</b>	<b>Position Führung</b>	Guide position	Position guidage
<b>X</b>	<b>Bohrung Frontbefestigung</b>	Drill hole front fixing	Perçage fixation de la face
<b>Y</b>	<b>Bohrung Position Steuerkurve</b>	Drill hole position radial cam	Perçage position came de commande
<b>Z</b>	<b>Kante Position Steuerkurve</b>	Edge position radial cam	Bord position came de commande
<b>U</b>	<b>Position Führungsschiene</b>	Position guide track	Position rail de guidage

**Einbaugrößen/Installation dimensions/Dimensions de montage**

- Typ S** = KAM 1200-1799
- Typ M** = KAM 1800-2199
- Typ L** = KAM 2200-2400

**Übersicht/Overview/Synopsis:** 18

**In 4 Minuten fertig geplant und bestellbereit**  
Planned and ready for ordering in 4 minutes  
Planifié et prêt à être commandé en 4 minutes

[www.eku.ch/planningtools](http://www.eku.ch/planningtools)

**Einbaubeispiele/Mounting examples/Exemples de montage**

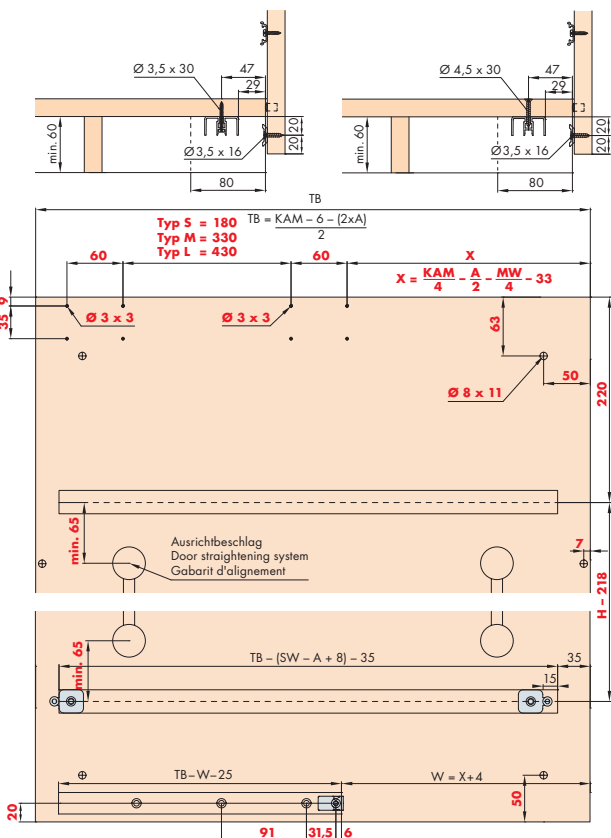

**D**

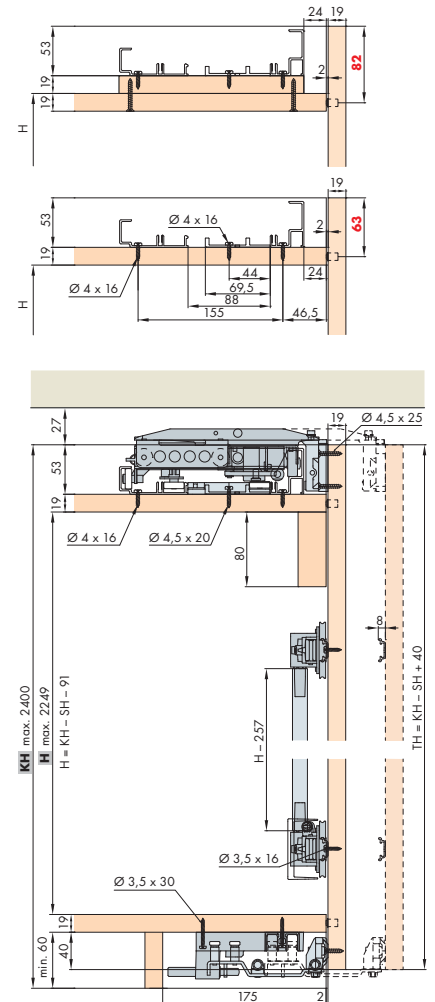
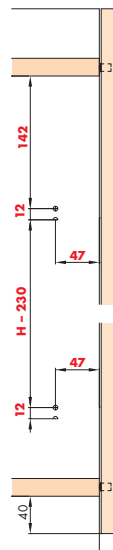

**Bearbeitung = rote Zahlen/Preparation = red numbers/Préparation = numéros en rouge**

# EKU FRONTINO® 40 H Forslide (FS)

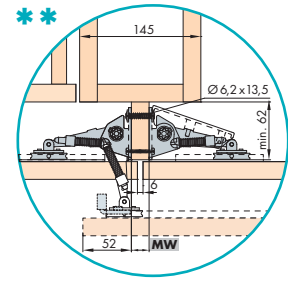
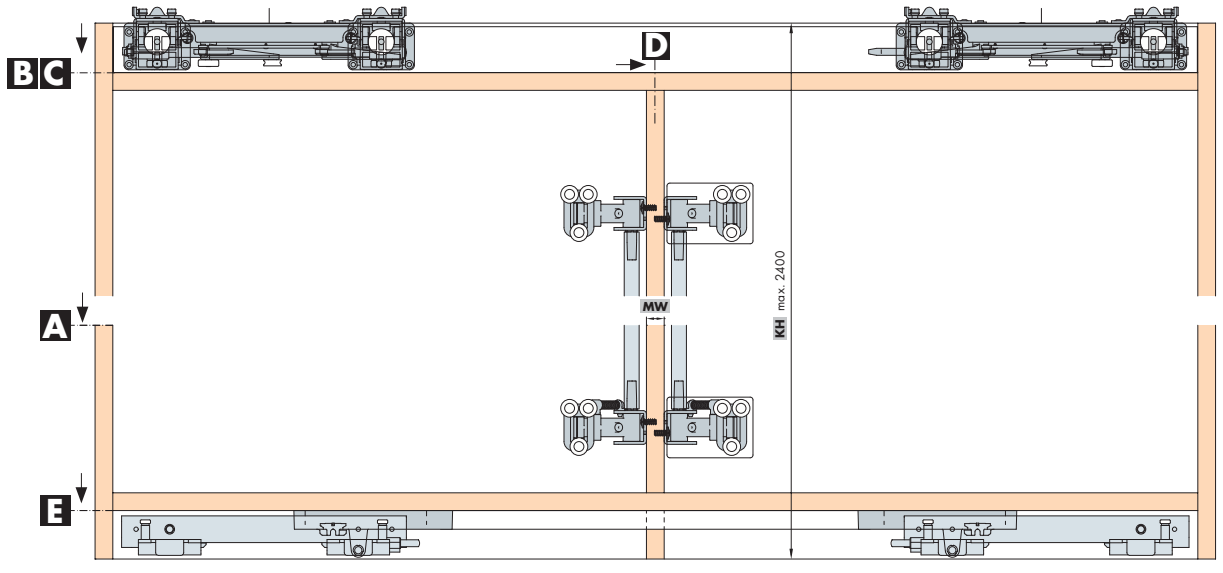
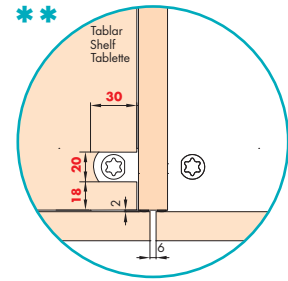
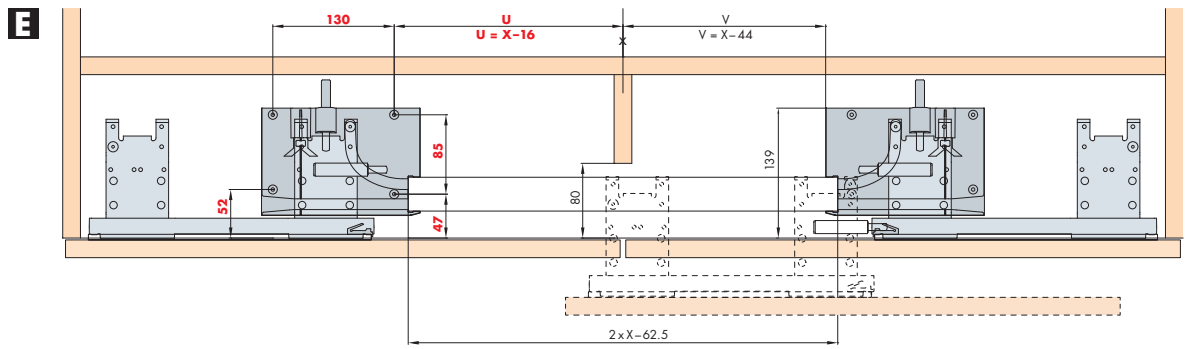
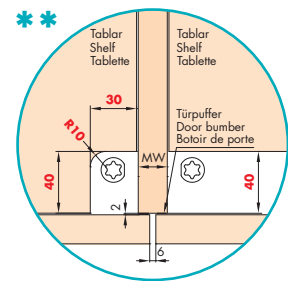
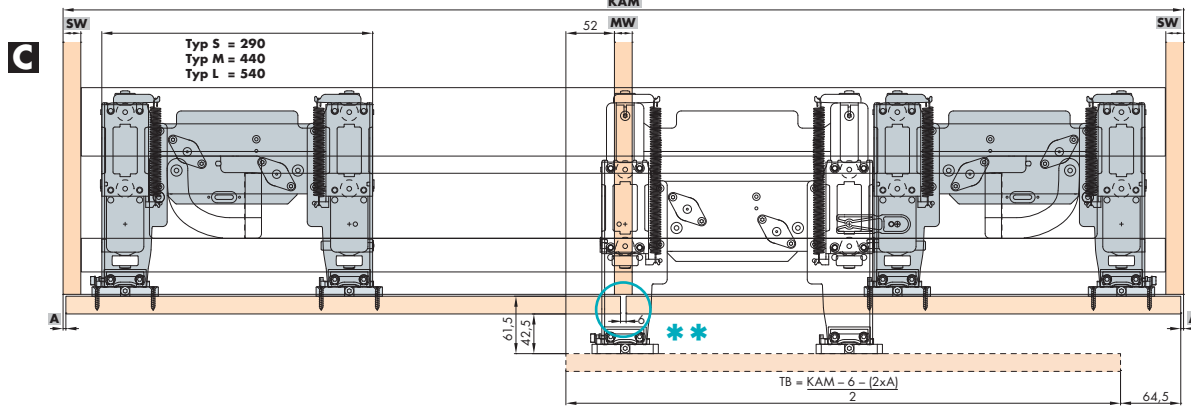
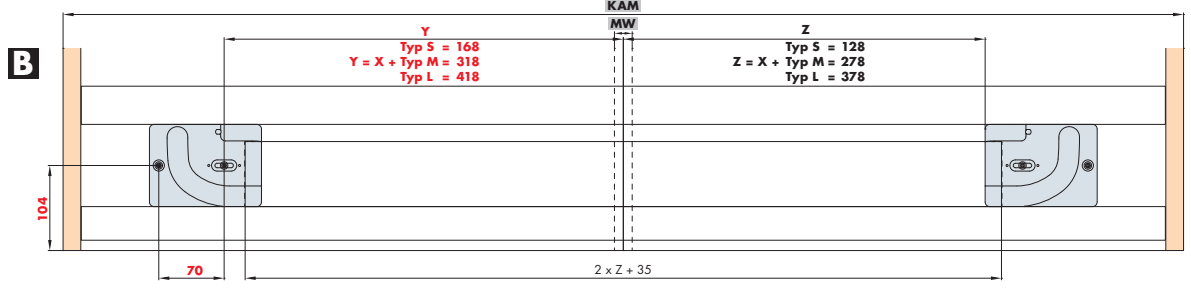
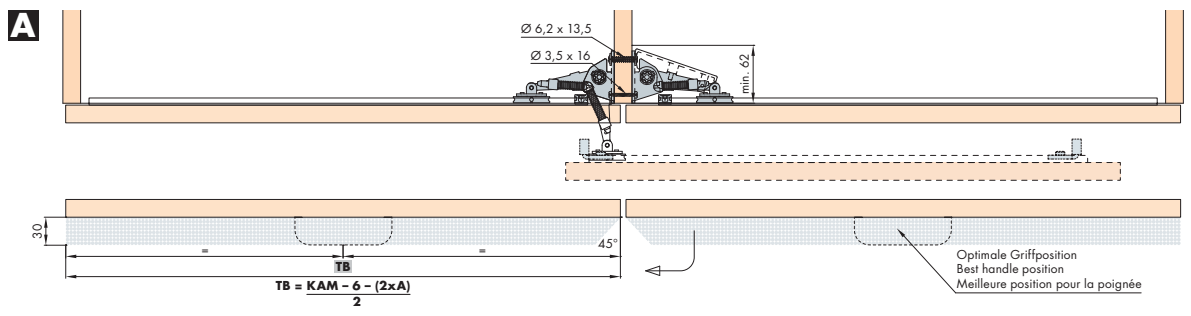

**Mit Auszug/Schublade**  
 With pull-out/drawer  
 Avec extension/tiroir

