

QUANTUM

STELAŻ PODWÓJNY
DOUBLE STEEL LEGS
Q 7112, Q 7114, Q 7116

MILA DESIGN

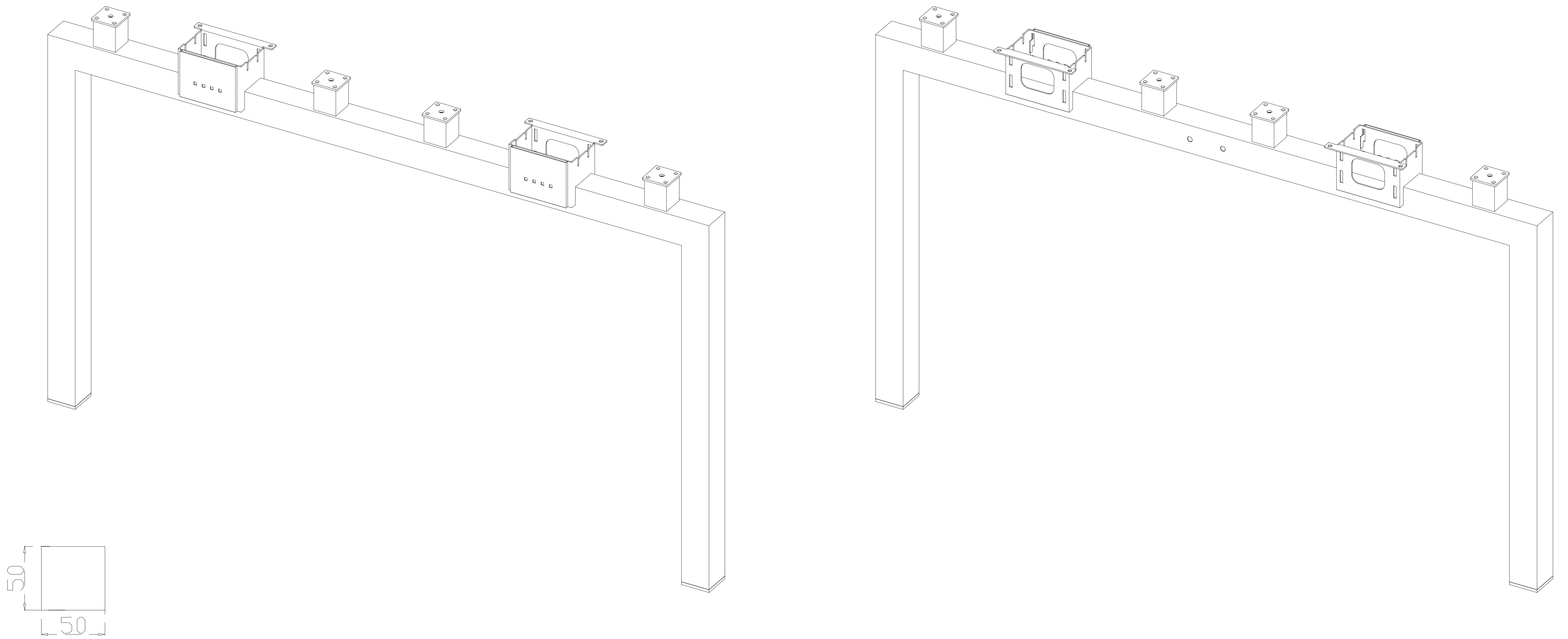

Q 7112
* 1200 mm

Q 7114
* 1400 mm

Q 7116
* 1600 mm

