

A stelaż biurka x 2 szt | steel legs x 2 pcs

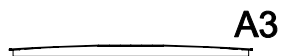

B zaślepka x 4 szt | end plug x 4 pcs

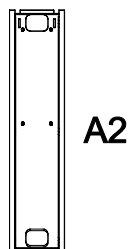

C regulator x 4 szt | adjustable feet x 4 pcs



D śruba x 8 szt | screw x 8 pcs



E klucz imbusowy x 1 szt | allen key x 1 pc



F wkręt x 8 szt | sharp screw x 8 pcs



INSTRUKCJA MONTAŻU | ASSEMBLY INSTRUCTION

ST 224

2019.08



1

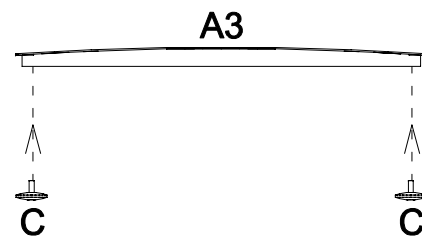
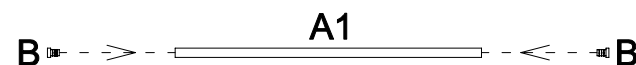

2

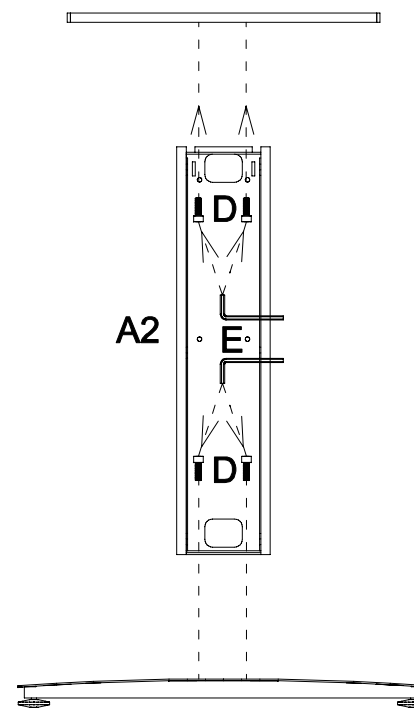

3

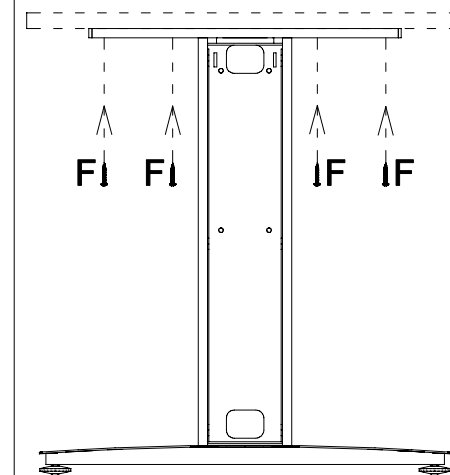

potrzebne narzędzia | necessary tools

