



 **ITALIANA**[®]
f e r r a m e n t a

Quick $\varnothing 35$

WORKTOP
CONNECTORS





SYMBOLS AND FINISHES LEGEND

SYMBOLS

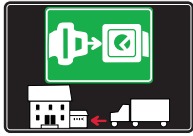

= SHELF SAFELY LOCKED DURING TRANSPORTATION AND AT HOME.



= ANTI-TURNOVER LOCKING SYSTEM



= NORMS / PATENTS



= PHILLIPS / POZIDRIV



= WITH BUFFER



= PART NO.



= BLADE SLOT



= WITH MAGNET



= PCS. PER PACKAGE



= COMBI SLOT



= HEXAGONAL SOCKET



= NEWTON



= CAPACITY LOADING



= HEXALOBULAR SOCKET



= FRICTION



= WOOD / GLASS THICKNESS



= COUNTERSUNK HEAD



= AUTOMATIC



= HOLE DIAMETER



= PAN HEAD



= DROP DOWN



= DIAMETER



= FLANGE HEAD



= LENGTH



= FLAT HEAD



= STANDARD HINGE



= HEIGHT



= TRILOBULAR SCREW



= KIMANA HINGE



= RIGHT VERSION



= SELF-TAPPING SCREW



= FLAP HINGE



= LEFT VERSION



= EURO THREAD



= WITH SPRING



= SETTING CODE



= METRIC THREAD



= WITHOUT SPRING



= PCS. PER PAD



= PRE-INSERTED SCREW



= REVERSED SPRING



= CUT ON REQUEST



= PRE-INSERTED SCREW AND SPREADING BUSH



= SELF ADHESIVE



= WITH FLANGE

NOTE: Printing errors and omissions may exist despite our best efforts to ensure accuracy. We reserve the right to alter specifications without notice.

MATERIALS

ZA = Zinc Alloy	ST = Steel	HSS = High Speed Steel	BR = Brass	ABS = Acrylonitrile Butadiene Styrene
ZAnk = Nickel-plated Zinc Alloy	STzk = Zinc-plated Steel	AL = Aluminium	WD = Wood	EVA = Ethylene Vinyl Acetate

EP = ENGINEERING PLASTIC	+ EP = other engineering plastic available on request	SR = SOFT RUBBER	+ SR = other soft rubber available on request
--	--	--------------------------------	--

EPn = Natural Engineering Plastic	EPc = Clear Engineering Plastic	SRn = Natural Soft Rubber
EPw = White Engineering Plastic	EPg = Grey Engineering Plastic	SRw = White Soft Rubber
EPwg = Water Green Engineering Plastic	EPa = Anthracite Engineering Plastic	SRb = Black Soft Rubber



FINISHES



+ **OTHER FINISHES AVAILABLE ON REQUEST**

PART NO.	FINISHES	PART NO.	FINISHES	PART NO.	FINISHES
00	Insignificant finish	IF	Middle Grey	RO	Red
AA	Natural	IJ	Light Grey	UT	T-Met 9007
AB	White	IL	Grey 20	UZ	T-Met
AE	White 9010	IN	Grey met. 26	WA	Bronzed
EA	Black	JB	Bright Aluminium	WI	Burnished
EC	Matt Black	JC	Aluminium - Chrome	XD	Satin-finished Steel
EE	Anthracite	JD	Matt Aluminium	YA	Nickel-plated
EW	Grey 9007	JE	Satin-finished Aluminium	YB	Bright Nickel-plated
FU	Gunmetal	JF	Aluminium - Brass	YC	Matt Nickel-plated
FV	Gunmetal V52	JG	Aluminium 5	YD	Satin-finished Nickel-plated
GR	Raw	JL	Aluminium PE 11	YQ	Black Nickel
HA	Brass-Plated	JM	Aluminium RAL 9006	Z9	Black Zinc
HH	Tropicalized	KA	Chrome	ZA	Zinc alloy
HL	Raw Brass	KB	Bright Chrome	ZN	Zinc-plated
HX	Graphite	KC	Matt Chrome	ZQ	Bright Gold
IA	Grey	LD	Brown 8019	ZY	Titanium
IB	Metallic Grey	NN	Metallic Beige	ZZ	Clear

QUICK

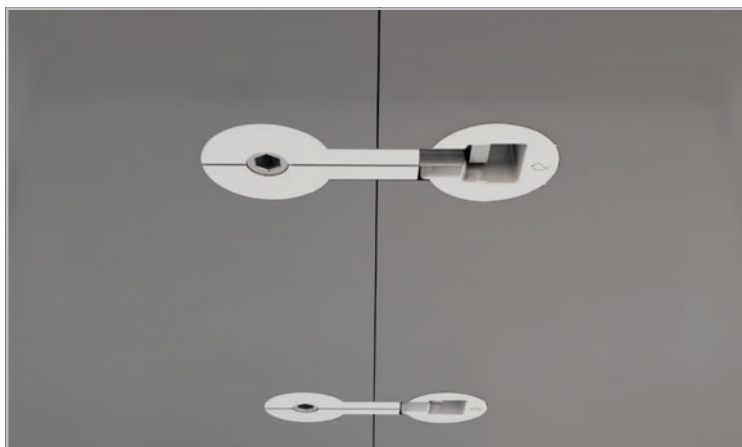

QUICK Ø35 has been conceived to join two worktops or panels together.

It consists of two parts:

- main body with tightening dowel M8x64, M8x100 or M8x150;
- round cap to suit the dowel head.

The installation is fast and simple as the two parts don't fall when placed in position.

The fastening becomes easier by using an S6 mm allen wrench, or even better, a cordless driver.

It is suitable for worktops and panels minimum 25 mm thick.

The tightening is 6 mm.

25 mm min.

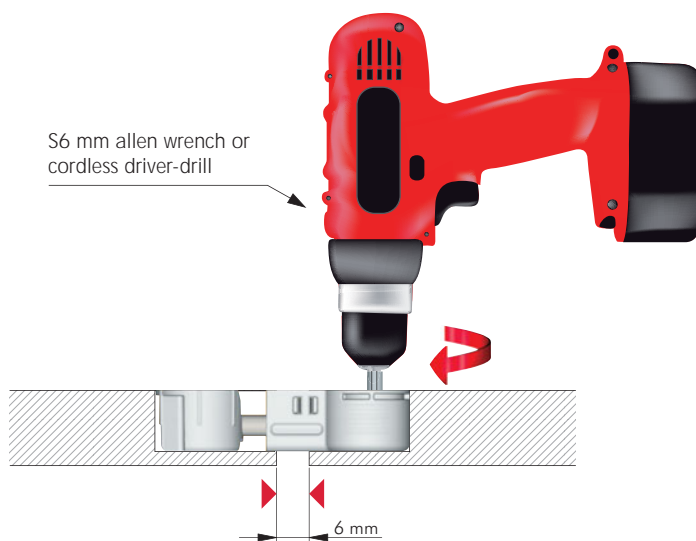
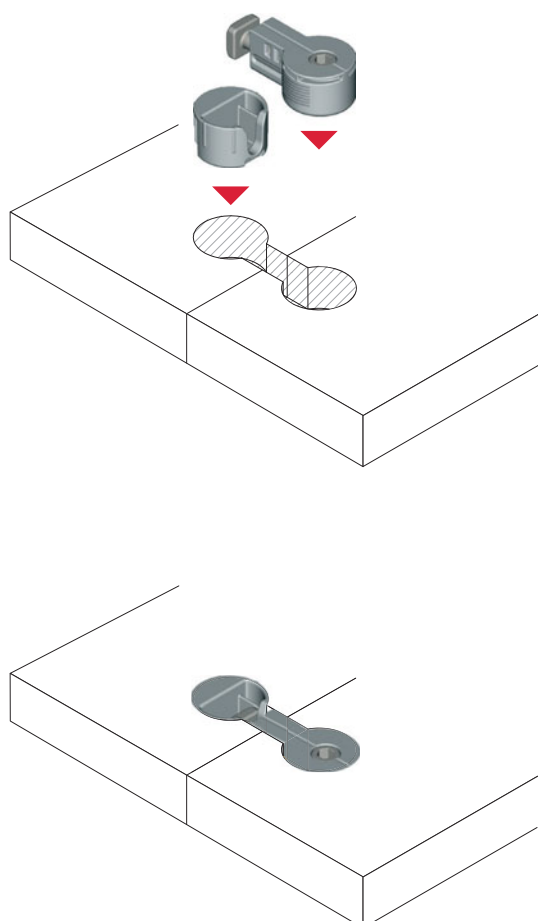

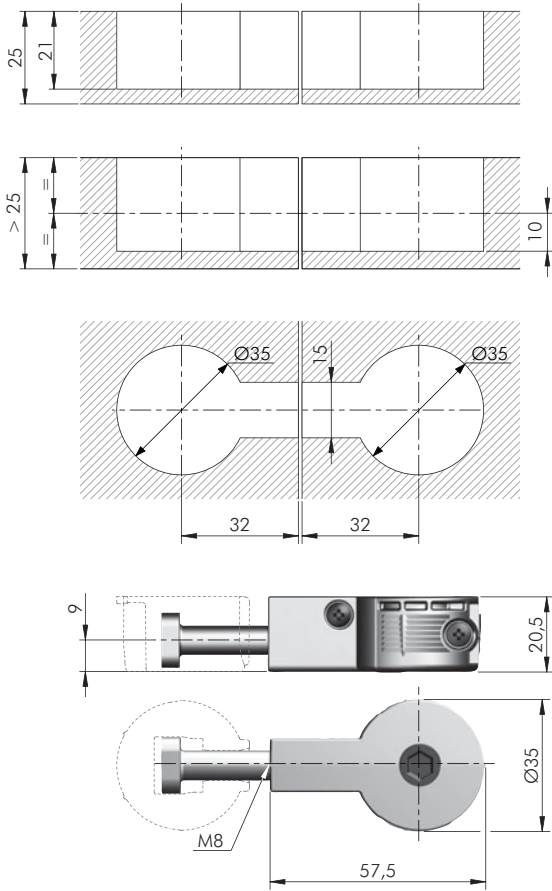

	= Ø 35 mm		= S6
	ZA		ST
	EP		= 250 pcs.
	2162101000		

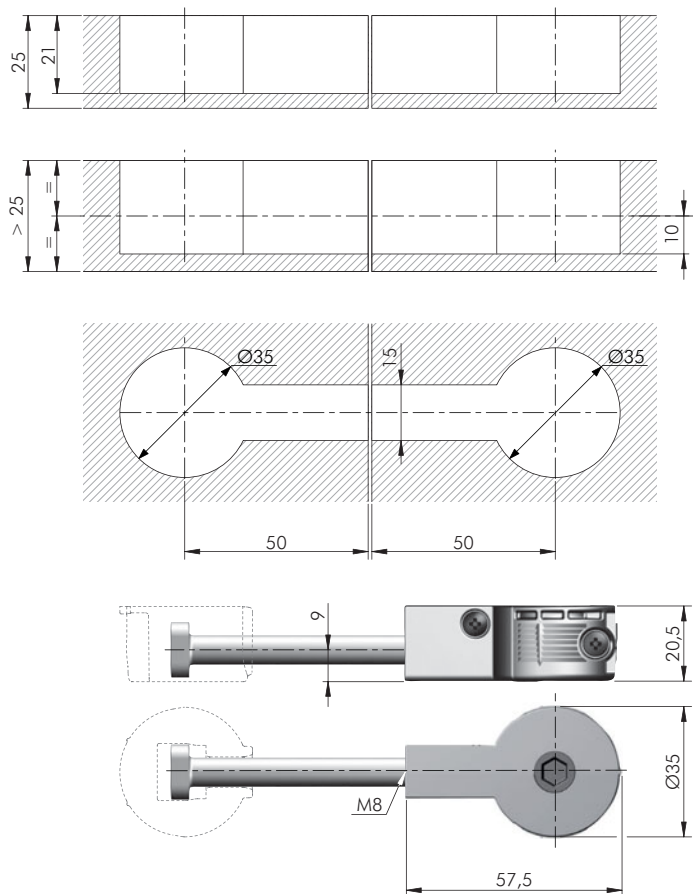



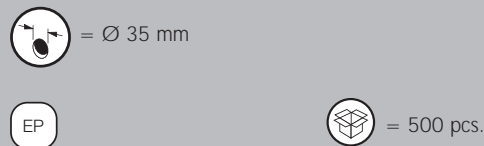
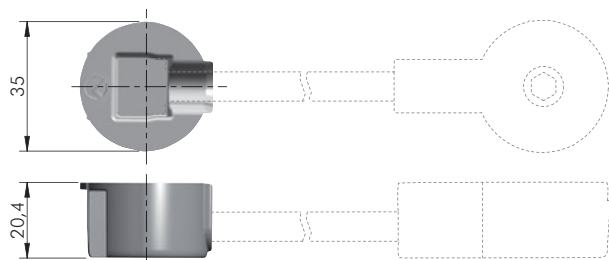
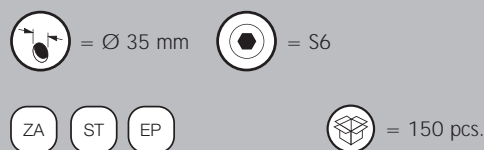
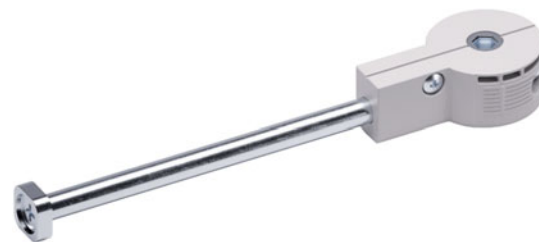
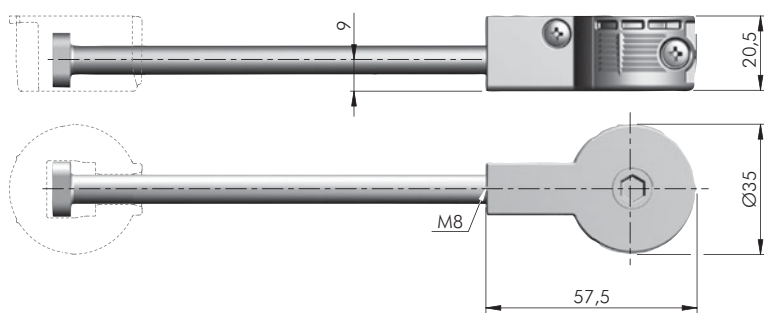
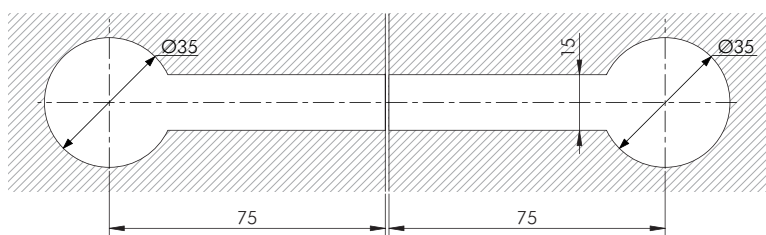
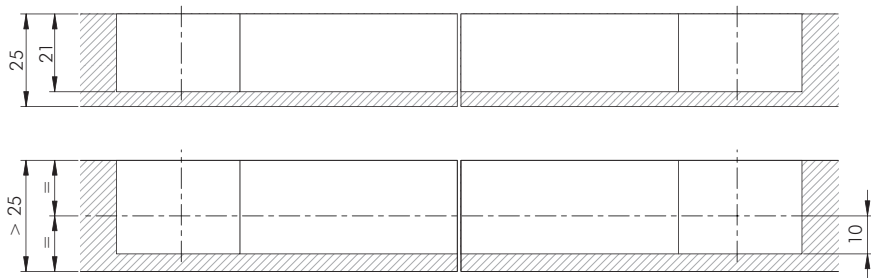

	= Ø 35 mm		= S6
	ZA		ST
	EP		= 150 pcs.
	2162104000		



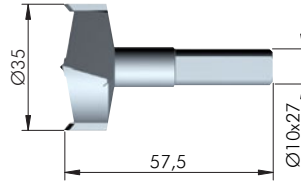
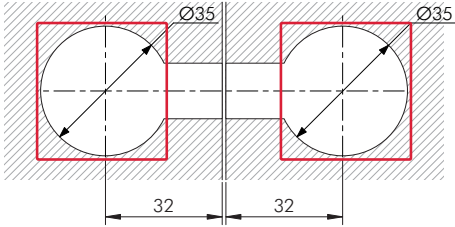





DRILL BIT FOR QUICK Ø 35 mm

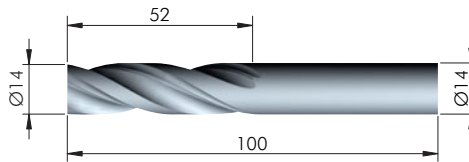
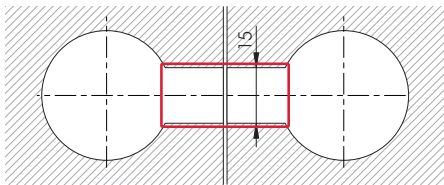

HSS	 = on request
	
3175201000	



HSS	 = on request
	
1621454000	

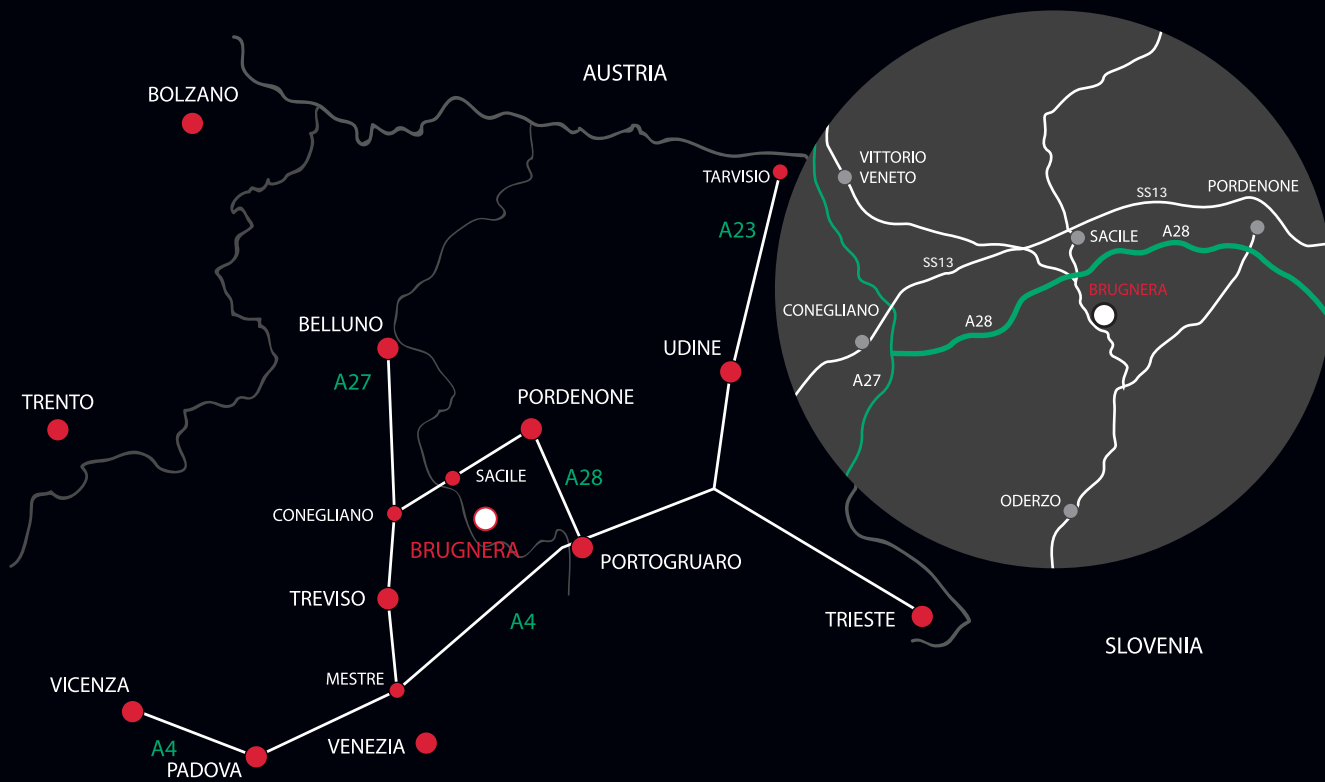

www.italianaferramenta.it