

Incara™ Disq'In

Cat. No(s): 6 547 40 to 45 - 6 547 55 to 57 - 6 547 59 to 61 - 6 547 63 to 65

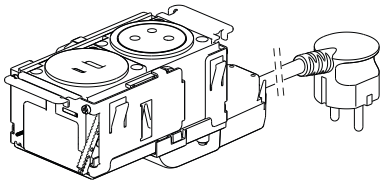

6 547 40/43

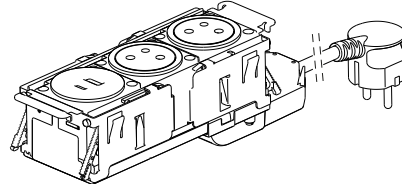

6 547 41/44

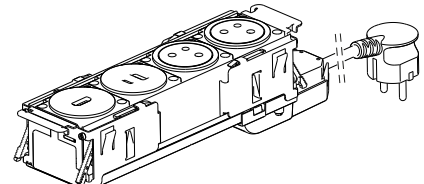

6 547 42/45

1. USE

Incara™ Disq'In is an aesthetic integrated solution for individual desks and meeting rooms tables. The range is available in 2, 3 and 4 gang and provides essential functions for workstation. Provided with fast fixing claws system, Incara™ Disq'In is easy and fast to install. For a perfect finish, metal plates are available in white, black or brushed metal.

2. RANGE

| Incara™ Disq'In 2 m cord equipped with: | | | Standards | 2 gang | | 3 gang | | 4 gang | |
|---|-----------|---|--------------------|----------|----------|----------|----------|----------|-------|
| | | | | White | Black | White | Black | White | Black |
| 1x 2P+E | 1 USB A+C | - | Franco/ Belgian | 6 547 40 | 6 547 43 | - | - | - | - |
| | | - | | - | - | 6 547 41 | 6 547 44 | - | - |
| 1 HDMI | - | - | | - | - | - | 6 547 42 | 6 547 45 | |

| Metal finishes plates* | 2 gang | 3 gang | 4 gang |
|------------------------|----------|----------|----------|
| | | | |
| Metal | 6 547 55 | 6 547 59 | 6 547 63 |
| White | 6 547 56 | 6 547 60 | 6 547 64 |
| Black | 6 547 57 | 6 547 61 | 6 547 65 |

* (4 additional colors available on demand)

3. DIMENSIONS

3.1 Finishes plates Incara™ Disq'In

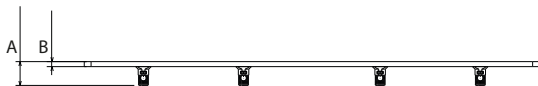

| Cat. Nos | A | B |
|----------------|------|-----|
| 6 547 55/56/57 | 10.4 | 2.2 |
| 6 547 59/60/61 | | |
| 6 547 63/64/65 | | |

3. DIMENSIONS (cont.)

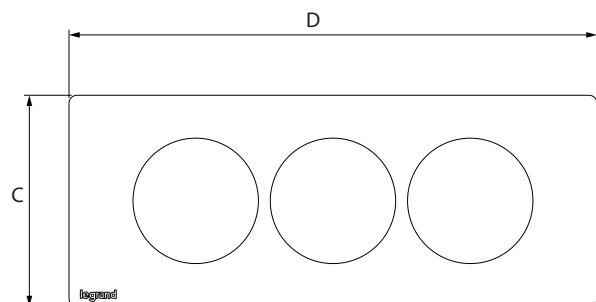

| Cat. Nos | C | D |
|----------------|----|-----|
| 6 547 55/56/57 | 80 | 148 |
| 6 547 59/60/61 | | 200 |
| 6 547 63/64/65 | | 252 |

3. DIMENSIONS (cont.)

3.2 2G-3G-4G Incara™ Disq'In: Top view

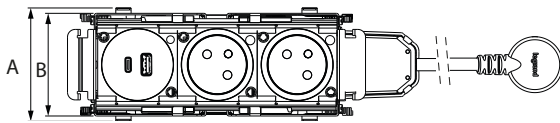

| Cat. Nos | A | B |
|-------------------------|----|----|
| 6 547 40/41/42/43/44/45 | 74 | 67 |

3.3 Incara™ Disq'In: Side view

2 gang

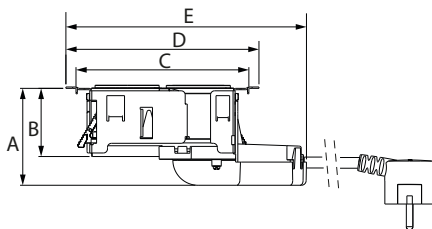

| Cat. Nos | A | B | C | D | E |
|-------------|----|----|-------|-------|-------|
| 6 547 40/43 | 71 | 50 | 126.8 | 141.6 | 176.4 |

3 gang

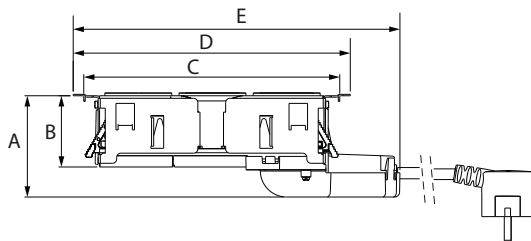

| Cat. Nos | A | B | C | D | E |
|-------------|----|----|-------|-------|-------|
| 6 547 41/44 | 71 | 50 | 179.7 | 194.5 | 229.4 |

4 gang

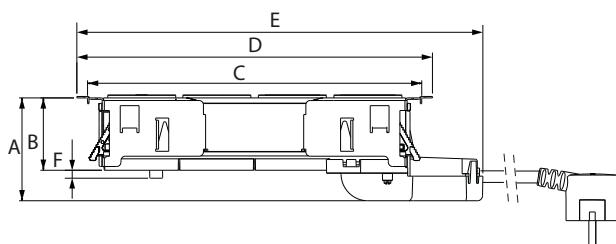

| Cat. Nos | A | B | C | D | E | F |
|-------------|----|----|-----|-------|-------|-----|
| 6 547 42/45 | 71 | 50 | 231 | 245.8 | 280.6 | 5.5 |

4. INSTALLATION

Must not be fitted on the floor

4.1 Into the desk

4.1.1 Drilling dimensions

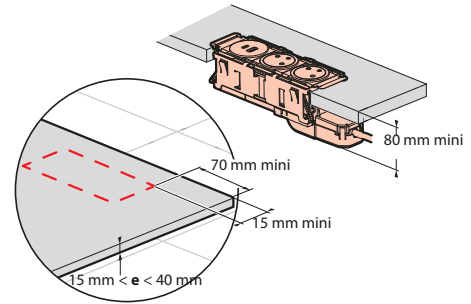

4.1.2 Max cut-out radius in corners

4.1.2.1 Sharp edges cut-out

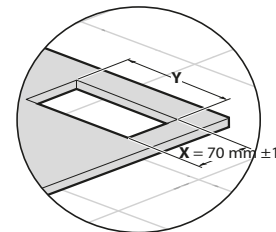

| | Y ± 1mm |
|-------------|---------|
| 6 547 40/43 | 129.5 |
| 6 547 41/44 | 181.5 |
| 6 547 42/45 | 233.5 |

4.1.2.2 CNC machining cut-out



| X | R1 MAX | R2 MAX |
|----|--------|--------|
| 76 | 12 | 6 |

4. INSTALLATION (cont.)

4.1.3 Insertion and fixing

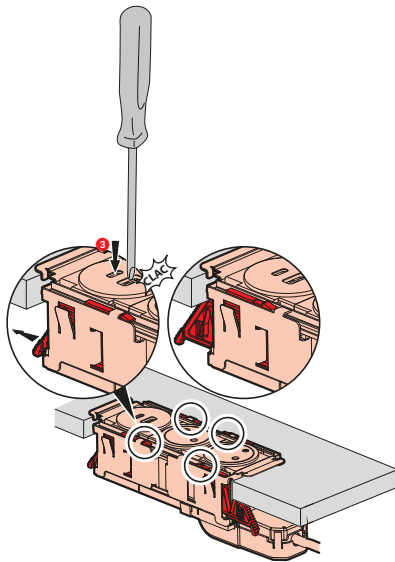
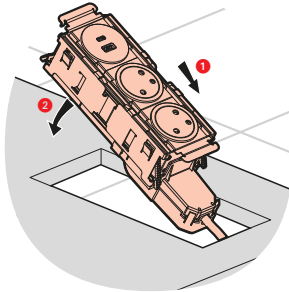

5. TECHNICAL CHARACTERISTICS

■ 5.1 Mechanical characteristics

Resistance to Impact: IK 07

Degree of protection provided by enclosures: IP 30

■ 5.2 Material characteristics

- Wiring devices frames: Polycarbonate

- Housing:

- . ABS
- . galvanised steel (Z275)
- . aluminium

- Finishes plates:

- . Brushed aluminium + varnish
- . Painted aluminium: black mat
- . Painted aluminium: white satin

5. TECHNICAL CHARACTERISTICS (cont.)

■ 5.3 Electrical characteristics

5.3.1 2 P+E plugs characteristics

16A-250V~ 3680W max - 230 V ~

Frequency: 50/60 Hz

5.3.2 USB charger type (LXX15)

| | |
|------------------------------|--|
| Trade mark |  |
| Address | 128, av. du Maréchal-de-Lattre-de-Tassigny - 87045 LIMOGES Cedex Tel. : 0 (+33) 5 55 06 87 87 Fax : 0 (+33) 5 55 06 88 88 www.legrand.com |
| Input voltage | 110-240V |
| Input AC frequency | 50-60Hz |
| Output voltage | 5,0V |
| Output current | 3,0A |
| Output power | 15,0W |
| Average active efficiency | 83,9% |
| Efficiency at low load (10%) | 83,3% |
| No-load power consumption | 0,06W |

5.3.3 Cords characteristics

H05VV-F 3G 1.5mm²

■ 5.4 Climate characteristics

Operating temperature: from -5°C to +35°C

Storage temperature: from -10°C to +70°C

6. CLEANING

Superficial cleaning with a soft cloth. Do not use abrasive products or detergents

Caution: Always test before using other special cleaning products

7. STANDARDS & APPROVALS

Compliant to NF C61-314 and IEC 60884-1

Chargeur USB compliant to IEC 62368-1