

304

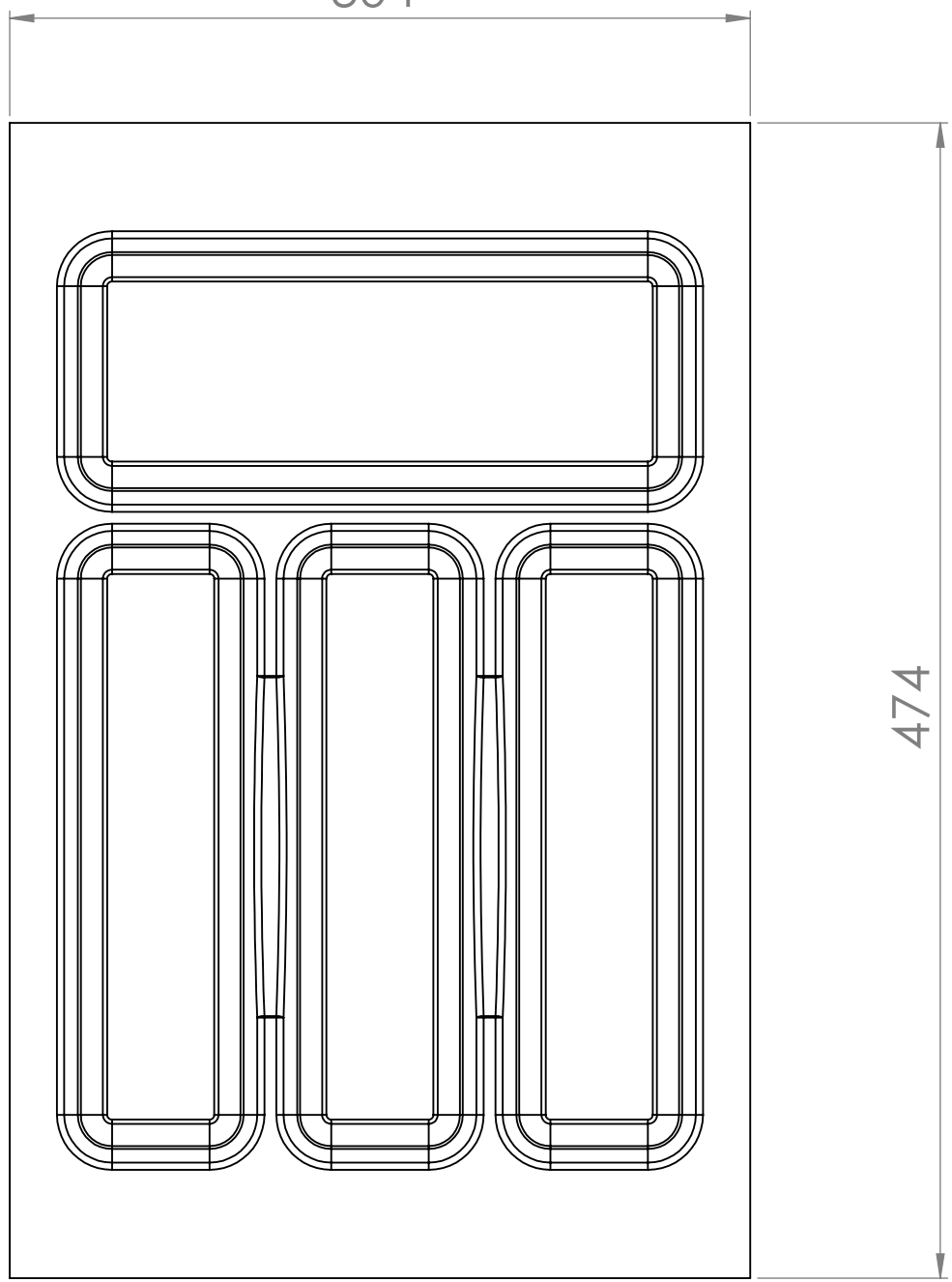

474