

Fitting for top-running glass doors up to 80 kg (176 lbs.), with running track flush with the ceiling. Optionally with soft and self closing mechanism. Wall or ceiling mounting. Minimal installation height.

Product highlights

- Aesthetics** Cover caps in different design versions
- Productivity** Easy height adjustment via both suspensions on completely installed door

Technical specifications

- Max. 80 kg (176 lbs.)
- Max. 4000 mm (13'1 15/32")
- Max. 3000 mm (9'10 1/8")
- 8-12.7 mm (5/16" to 1/2")

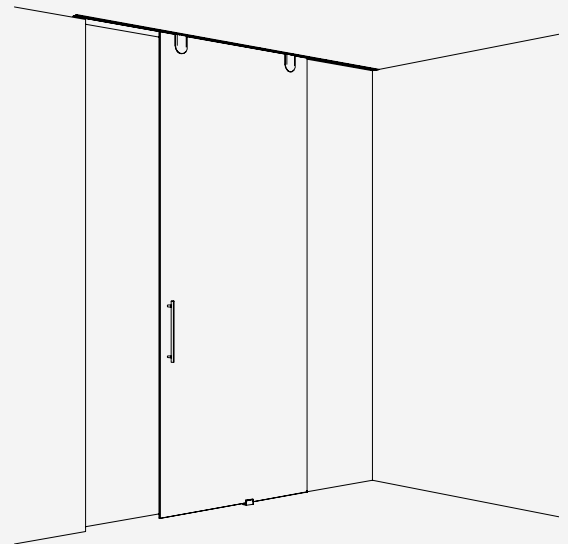

Installation examples

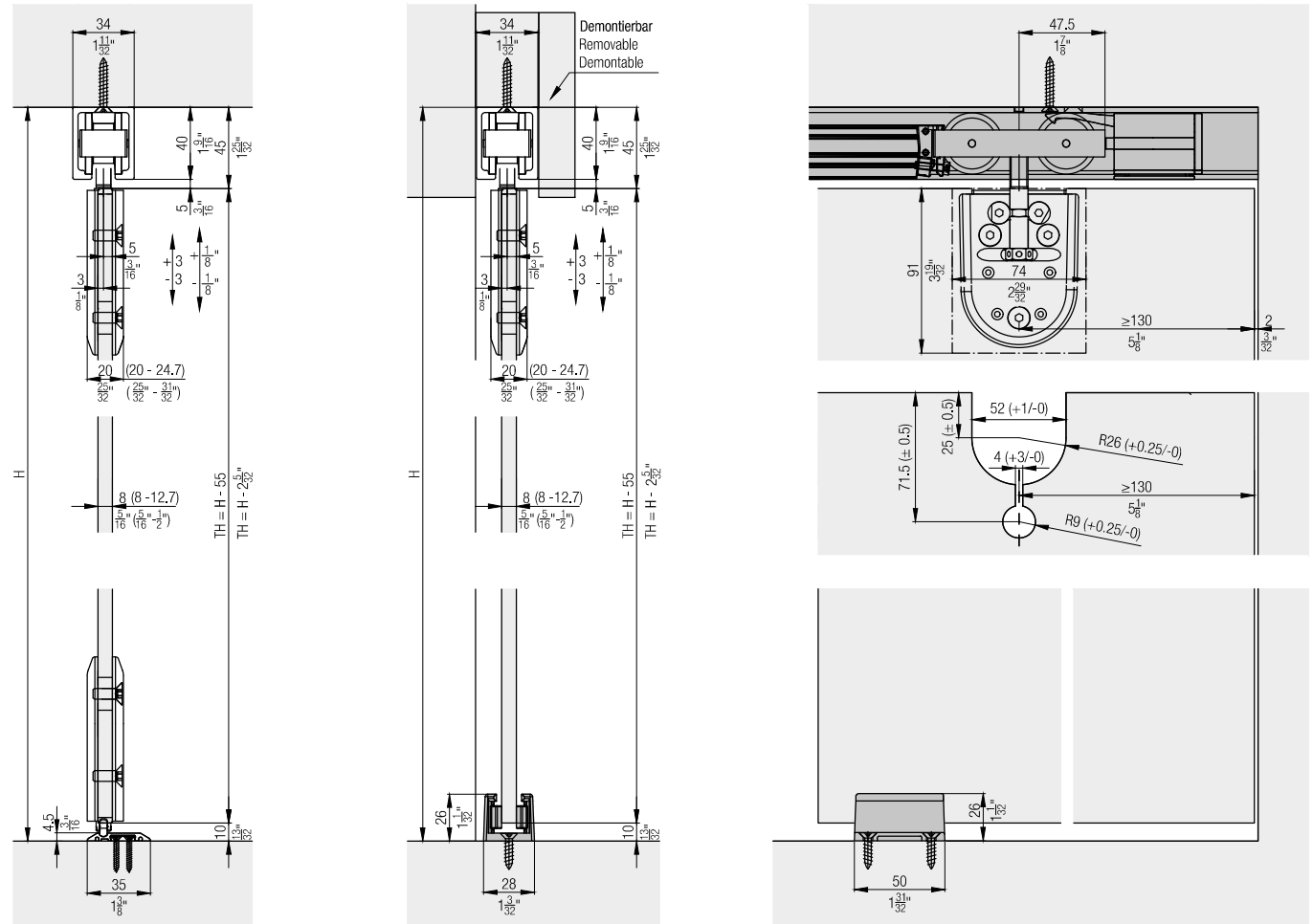



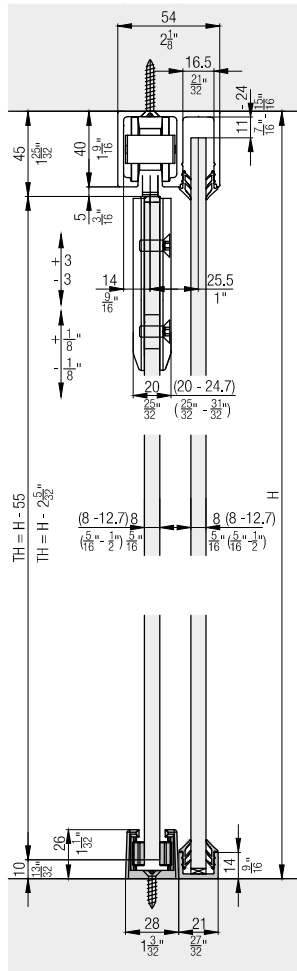
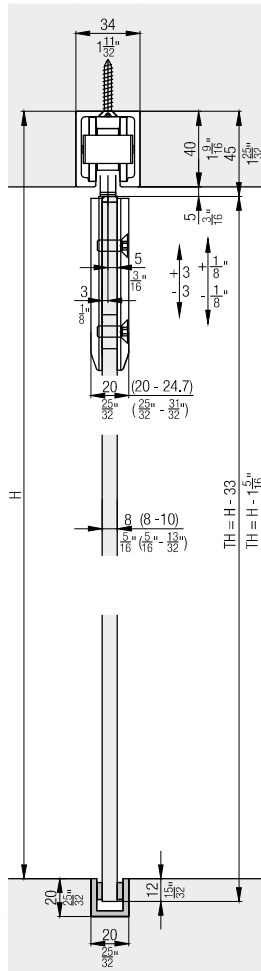
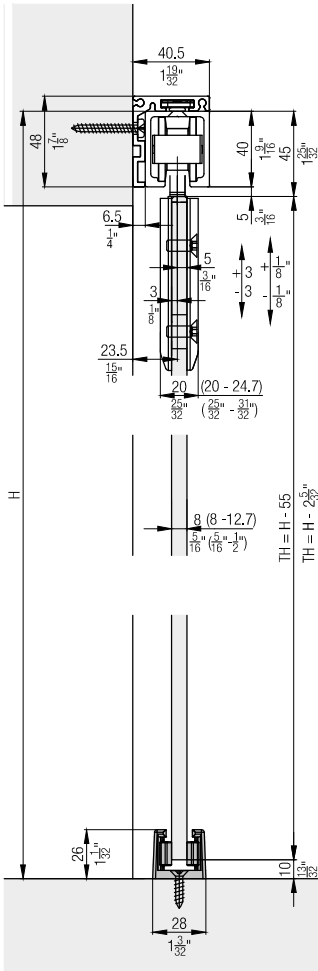



Further installation examples



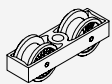
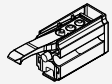







Set for 1 glass door up to 80 kg (176 lbs.)

	No.
Hawa Junior 80 GP, for 1 door	20491
Hawa Junior 80 GP, for 1 door, with 1 soft closing mechanism SoftMove 80	23091
Hawa Junior 80 GP, for 1 door, with 2 soft closing mechanisms SoftMove 80	23092







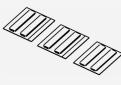
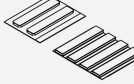
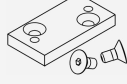





Set consisting of:

		20491	23091	23092	No.
	Running gear, 2-wheeled, M10, plastic wheels	2	2	2	10407
	Stopper Hawa Junior 80/100, with adjustable retention spring	2	2	2	30138
	Suspension bolt M10 and mounting screws	2	2	2	16018
	Patch suspension, with glass holder insert, without mounting screws	2	2	2	20505
	Screw-on rubber door stop	1	1	1	10629
	Single use drilling jig	1	1	1	20400
	Vertical adjustment pin	1	1	1	16329
	Soft closing mechanism SoftMove 80		1	2	22444

Bottom guides

		No.
	Stop bumper, complete, for guide track 15405/15554	15636
	Set of fixing parts for surface mounted bottom guide channel, 5-piece set	19162
	Spring bottom guide for point fixing, with mounting screw	19118
	Guide slider, rattle proof, plastic, with mounting screw, for patch suspension	16020
	Patch suspension, with glass holder insert, without mounting screws	20505
	Bottom guide, rattle proof, with self-adhesive sliders for satinised glass, glass thickness 8-12.7 mm (5/16"-1/2"), chrome-plated, matt	16029
	Bottom guide, rattle proof, with self-adhesive sliders for satinised glass, glass thickness 8-12.7 mm (5/16"-1/2"), stainless steel look	21267
	Bottom guide, rattle proof, groove width 10 mm (13/32"), plastic, black, 10-piece set	25958
	Sliders, for 10 mm glass (13/32"), self-adhesive, 6-piece set	16193
	Sliders, for 8 mm (5/16") glass, self-adhesive, 6-piece set	16192
	Distance plate to bottom guide	16657



Cover caps

		No.
	Cover cap, rounded, plastic, chrome-plated, matt, 1 piece	16049
	Cover cap, rounded, plastic, chrome-plated, matt, 4-piece set	16042
	Cover cap, rounded, plastic, chromium finish polished, 1 piece	17161
	Cover cap, rounded, plastic, chromium finish polished, 4-piece set	17160
	Cover cap, rounded, plastic, stainless steel look, 1 piece	16051
	Cover cap, rounded, plastic, stainless steel look, 4-piece set	16044
	Cover cap, rounded, plastic, raw, 1 piece	15823
	Cover cap, square, plastic, chrome-plated, matt, 1 piece	19091
	Cover cap, square, plastic, chrome-plated, matt, 4-piece set	19092
	Cover cap, square, plastic, stainless steel look, 1 piece	19093
	Cover cap, square, plastic, stainless steel look, 4-piece set	19094
	Square cover plate, plastic, raw, 1 piece	19000
	Cover cap to running track, both sides, steel, chrome-plated, matt	24956
	Cover cap to running track, both sides, steel, stainless steel look	24957

Running tracks

		mm (inch)	No.	
	Running track, aluminum, anodized, pre-drilled	1,400 (4' 7 1/8")	10189	
		1,600 (5' 3")	10190	
		1,800 (5' 10 7/8")	10191	
		2,000 (6' 6 3/4")	10192	
		2,200 (7' 2 5/8")	10193	
		2,500 (8' 2 7/16")	10194	
		3,000 (9' 10 1/8")	18532	
		4,000 (13' 1 15/32")	18533	
		6,000 (19' 8 7/32")	10186	
		cut to size	10188	
		Running track, aluminum, stainless steel look, brushed, pre-drilled	2,500 (8' 2 7/16")	22048
			4,000 (13' 1 15/32")	20005
			6,000 (19' 8 7/32")	20004
cut to size	20006			

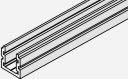

Guide tracks

		mm (inch)	No.
	Surface-mounted guide track, aluminum, anodized	2,500 (8' 2 7/16")	19348
		3,500 (11' 5 25/32")	19349
		6,000 (19' 8 7/32")	18956
		cut to size	19350
	Guide track, aluminum, anodized	6,000 (19' 8 7/32")	15405
		cut to size	15554
	Guide track, aluminum, anodized, pre-drilled	6,000 (19' 8 7/32")	14414
		cut to size	14415

**Running track set with fixed glazing,
2500 mm (8'2 7/16"), aluminum, anodized**

	No.
Set running tracks, with fixed glass, aluminum, anodized, pre-drilled	20226



	20226	No.
Set consisting of:		

	Running track, with fixed glass, aluminum, anodized, pre-drilled	1	20104
	Cover profile to running track with fixed glass, aluminum, anodized	1	19552

**Running track set with fixed glazing,
4000 mm (13'1 7/16"), aluminum, anodized**

	No.
Set running tracks, with fixed glass, aluminum, anodized, pre-drilled	20227



	20227	No.
Set consisting of:		

	Running track, with fixed glass, aluminum, anodized, pre-drilled	1	20105
	Cover profile to running track with fixed glass, aluminum, anodized	1	19553

**Running track set with fixed glazing,
6000 mm (19'8 7/32"), aluminum, anodized**

	No.
Set running tracks, with fixed glass, aluminum, anodized, pre-drilled	20228



	20228	No.
Set consisting of:		

	Running track, with fixed glass, aluminum, anodized, pre-drilled	1	20106
	Cover profile to running track with fixed glass, aluminum, anodized	1	19562

**Running track set with fixed glazing,
2500 mm (8'2 7/16"), aluminum, stainless steel effect**

	No.
Running track set, with fixed glass, aluminum, stainless steel look, brushed, pre-drilled	21270



	21270	No.
Set consisting of:		

	Running track, with fixed glass, aluminum, stainless steel look, brushed, pre-drilled	1	21276
	Cover profile to running track, with fixed glass, stainless steel effect, brushed	1	21280

**Running track set with fixed glazing,
4000 mm (13'1 7/16"), aluminum, stainless steel effect**

	No.
Running track set, with fixed glass, aluminum, stainless steel look, brushed, pre-drilled	21271



	21271	No.
Set consisting of:		

	Running track, with fixed glass, aluminum, stainless steel look, brushed, pre-drilled	1	21277
	Cover profile to running track, with fixed glass, stainless steel effect, brushed	1	21281

**Running track set with fixed glazing,
6000 mm (19'8 7/32"), aluminum, stainless steel effect**

	No.
Running track set, with fixed glass, aluminum, stainless steel look, brushed, pre-drilled	21272

	21272	No.
Set consisting of:		

	Running track, with fixed glass, aluminum, stainless steel look, brushed, pre-drilled	1	21278
	Cover profile to running track, with fixed glass, stainless steel effect, brushed	1	21282

Soft close SoftMove 80



 For soft closing in opening and closing direction
 order 2 sets.

		No.
	Soft closing mechanism SoftMove 80	22444

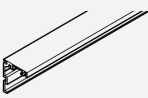
Angled profiles for wall mounting



		mm (inch)	No.
	Angled profile for wall mounting, aluminum, anodized, pre-drilled	2,500 (8' 2 7/16")	24953
		4,000 (13' 1 15/32")	24952
		6,000 (19' 8 7/32")	24951
		cut to size	24954

Individual components to angled profile

		No.
	Assembly set to angled profile, 10-piece set	17786
	Cover cap to angled profile, steel, chrome-plated, matt, suitable to both side	24961
	Connecting pins to profiles, 2-piece set	21347



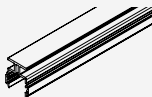
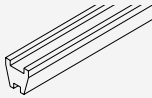
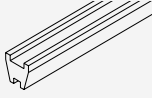
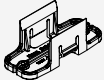

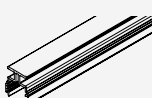
**Hawa Adapto 80 concrete casting system,
without fixed glazing**

		No.
Inset profile for concrete surfaces Hawa Adapto 80, without fixed glass, 2500 mm (8'2 7/16")		20216
Inset profile for concrete surfaces Hawa Adapto 80, without fixed glass, 4000 mm (13'1 15/32")		20217

		mm (inch)	20216	20217	No.
Set consisting of:					
	Inset profile for concrete surfaces, without fixed glass, aluminum	2,500 (8' 2 7/16")	1		20087
	Polysty- rene insert, without fixed glass	1,000 (3' 3 3/8 ")	2	4	19418
	Polysty- rene insert, without fixed glass	500 (1' 7 11/16")	1		19556
	Assembly clips, plastic, black, without fixed glass		4	5	19344
	Cover cap, without fixed glass, plastic, gray		2	2	19366
	Inset profile for concrete surfaces, without fixed glass, aluminum	4,000 (13' 1 15/32")		1	20088

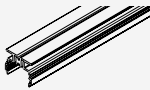
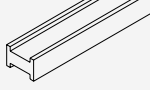
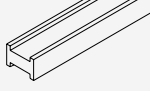



Hawa Adapto 80 concrete casting system, with fixed glazing

	No.
Inset profile for concrete surfaces Hawa Adapto 80, with fixed glass, 2500 mm (8'2 7/16")	20220
Inset profile for concrete surfaces Hawa Adapto 80, with fixed glass, 4000 mm (13'1 15/32")	20221



Set consisting of:		mm (inch)	20220	20221	No.
	Inset profile for concrete surfaces, with fixed glass, aluminum	2,500 (8' 2 7/16")	1		20094
	Polystyrene insert, 1000 mm (3'3 1/4"), with fixed glass	1,000 (3' 3 3/8")	2	4	19555
	Polystyrene insert, with fixed glass	500 (1' 7 11/16")	1		19557
	Assembly clips, plastic black, with fixed glass		4	5	19568
	Cover cap, fixed glass, plastic, gray		2	2	19968
	Inset profile for concrete surfaces, with fixed glass, aluminum	4,000 (13' 1 15/32")		1	20095

Assembly set for Hawa Adapto 80

	No.
Assembly set, with countersunk head screw, length up to 2500 mm (8'2 7/16")(8'2 7/16")	22841
Assembly set, with countersunk head screw, length 2501–4000 mm (8'2 15/32"–13'1 15/32")	22842

Set consisting of:		22841	22842	No.
	Distance plate, plastic, 1 mm (1/32")	2	2	19398
	Distance plate, plastic, 2 mm (3/32")	2	2	19399
	Distance plate, plastic, 3 mm (1/8")	2	2	19400
	Distance plate, plastic, 5 mm (3/16")	4	4	19401
	Countersunk screws special, 6x20 mm (1/4"x25/32"), 10-piece set	1	2	22844



Base/wall profiles and rubber profiles for fixed glazing

		mm (inch)	No.
	Bottom-/wall profile to fixed glass, aluminum, anodized, pre-drilled	4,000 (13' 1 15/32")	19549
		6,000 (19' 8 7/32")	19561
		cut to size	20067
	Bottom-/wall profile to fixed glass, aluminum, stainless steel look, brushed, pre-drilled	4,000 (13' 1 15/32")	21285
		6,000 (19' 8 7/32")	21286
		cut to size	21287
	Rubber profile, black, to fixed glass 8–9.9 mm (5/16"–13/32")	10,000 (32'9 11/16")	25787
	Rubber profile, black, to fixed glass 10–12 mm (13/32"–15/32")	10,000 (32'9 11/16")	25789
	Rubber profile, black, to fixed glass 12.1–13.1 mm (15/32"–1/2")	10,000 (32' 9 11/16")	25763

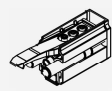
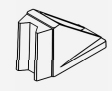
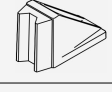

Vertical sealing profiles

		mm (inch)	No.
	Vertical seal 13/18, aluminum, anodized, for fixed glass with glass distance 13–18,5 mm (1/2"–3/4")	2,500 (8' 2 7/16")	20283
		3,500 (11' 5 25/32")	20284
	Vertical seal 13/18, aluminum, stainless steel look, brushed, for fixed glass distance 13–18,5 mm (1/2"–3/4")	2,500 (8' 2 7/16")	21290
		3,500 (11' 5 25/32")	21291
	Vertical seal 20/22, aluminum, anodized, for fixed glass with glass distance 20–22 mm (25/32"–7/8")	2,500 (8' 2 7/16")	20650
		3,500 (11' 5 25/32")	20651

Accessories

		No.
	SoftStop Hawa Junior 80/100, with adjustable retention spring	27771
	Bottom door stopper, with centering, stainless steel look	21473
	Bottom door stopper, with centering, chrome-plated, matt	20773
	Centering assembly grey, for all glass sliding doors	18619
	Centering assembly black, for all glass sliding doors, to wall profile	18663

Wall connection

		mm (inch)	No.
	Wall profile, aluminum, anodized	2,500 (8' 2 7/16")	17020
		3,500 (11' 5 25/32")	17021
	Wall profile, aluminum, stainless steel look, brushed	2,500 (8' 2 7/16")	20119
		3,500 (11' 5 25/32")	20120
	Seal profile, black, for wall profile	2,500 (8' 2 7/16")	16452
		3,500 (11' 5 25/32")	16453

Protective edge trims

		mm (inch)	No.
	Rubber profile self-adhesive, black, for 8–12,7 mm (5/16"–1/2") glass thickness, glass distance 4 mm	5,000 (16' 4 27/32")	19442
		10,000 (32' 9 11/16")	19443
		50,000 (164' 1/2 ")	19444
	Rubber profile self-adhesive, translucent, for 8–12,7 mm (5/16"–1/2") glass thickness, glass distance 4 mm	5,000 (16' 4 27/32")	19445
		10,000 (32' 9 11/16")	19446
		50,000 (164' 1/2 ")	19447

SoftMove 80 soft closing mechanism

Completely integrated into the running track, the SoftMove decelerates sliding doors and draws them into their final position.

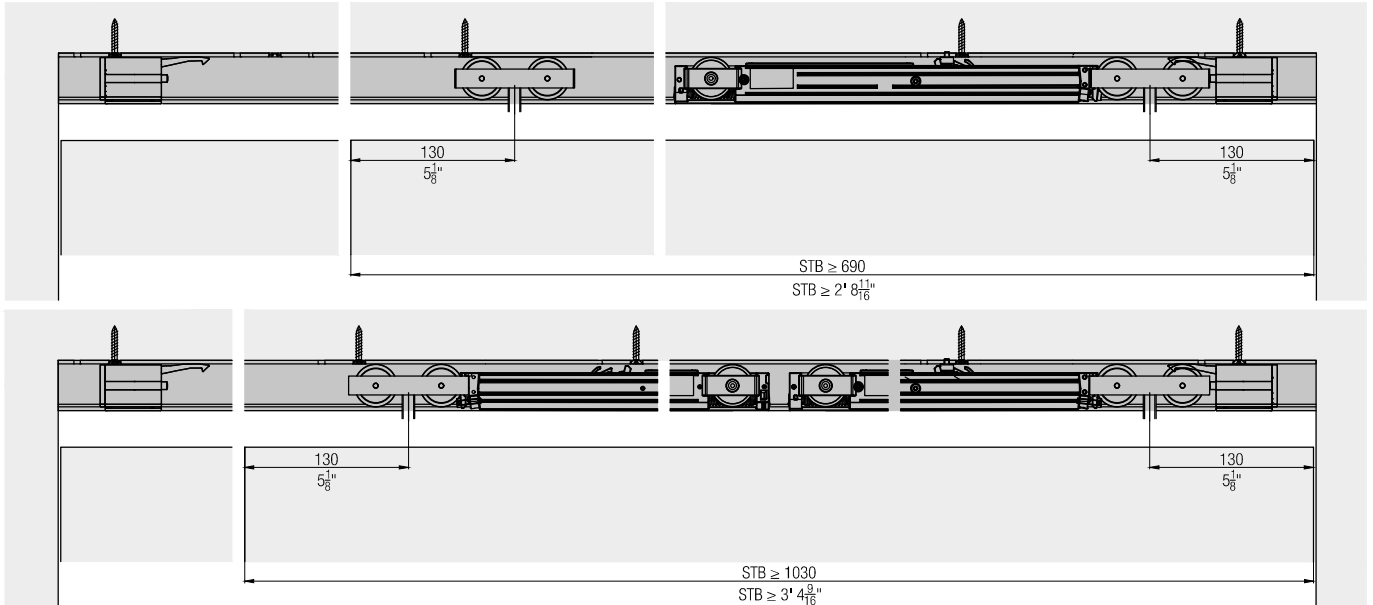

Accessories

- Lock solutions from page 511
- General accessories from page 518
- Glass recommendations from page 536

Planning/execution

Further information about the product can be found on www.hawa.com.