



Fine

The new aluminium frame for sliding doors
Il nuovo telaio in alluminio per ante scorrevoli



www.ternoscorrevoli.com/fine

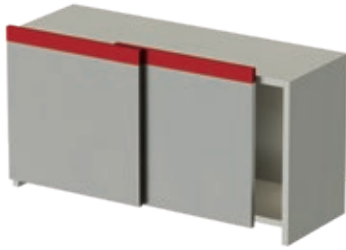

EXTERNAL OVERLAPPING DOORS
ANTE SOVRAPPOSTE ESTERNE

Fine

The aluminium frame for sliding doors - **elegant, functional and minimalist.**

Il telaio in alluminio per ante scorrevoli, **elegante, minimale e funzionale**



Design and Convenience

Not just beauty, but flexibility and sustainable costs as well.

Fine is the new aluminium frame for sliding doors, designed to meet the needs of a modern and sustainable market. The minimalist design can enhance the profile of wardrobes, making it possible to create modern solutions with a high aesthetic impact.

Its technical and construction characteristics guarantee **reduced manufacturing and storage costs**. As the only work required is cutting the profiles at 90°, manufacturing costs and time can be optimised.

Following the construction standards we have provided, it will be possible to assemble the frame, doors, guides and sliding systems **with no extra cuts, holes or finishing work required**.

This ambivalent advantage translates into **great aesthetic value, very easy assembly and reduced manufacturing costs**.

Design e Praticità

Non solo bellezza, ma flessibilità e sostenibilità dei costi.

Fine è il nuovo telaio in alluminio, per ante scorrevoli, progettato per rispondere alle esigenze di un mercato moderno e sostenibile.

Il design minimalista è in grado di esaltare le linee degli armadi, consentendo la realizzazione di soluzioni moderne e a forte impatto estetico.

Le sue caratteristiche tecniche e costruttive garantiscono una **riduzione dei costi di lavorazione e stoccaggio**. Grazie all'unica lavorazione necessaria: il taglio a 90° dei profili, è infatti possibile ottimizzare i tempi e i costi di lavorazione.

Seguendo gli standard costruttivi da noi forniti sarà possibile assemblare: telaio, ante, guide e sistemi scorrevoli

senza la necessità di ulteriori tagli, fori o lavorazioni aggiuntive.

Un vantaggio ambivalente, che si traduce in: un **grande valore estetico**, un'**estrema praticità di montaggio** e una **riduzione dei costi** di lavorazione.

8 mm... Fine Thinner and more resistant than ever.

The new visible frame is only 8 mm wide.

It is truly incredible if considering how resistant it is.

Once assembled, **it guarantees fluid movement**, especially if combined with our **Star Fluid** sliding system.

8 mm... Fine Mai così sottile e resistente.

Il nuovo telaio a vista è di soli 8 mm di larghezza.

Davvero incredibile, se si tiene conto della sua resistenza. Una volta assemblato, **garantisce** infatti una **scorrevolezza fluida** soprattutto se accostato al nostro sistema scorrevole **Star Fluid**.

One system, many advantages

Not just aesthetics, but construction flexibility and a range of options.

Fine has been designed to be a **flexible system** in construction terms as well.

With a single kit of accessories and seals, cabinets with **4 mm thick wooden and glass doors** (with and without crossbeams) can be made using the specific structural seals.



Un sistema, molti vantaggi

Non solo estetica, ma flessibilità costruttiva e possibilità di scelta.

Fine è stato concepito per essere un **sistema flessibile** anche in termini costruttivi.

Con un unico kit di accessori e guarnizioni, si possono realizzare armadi con **ante in legno** e **in vetro con spessore 4 mm** (con e senza traversi), utilizzando le apposite guarnizioni strutturali.



For wardrobes with 2 or 3 doors
A unique design that will leave you speechless

Thanks to its specific **framed design**, systems with 2 or 3 doors can be created **without the need to add and use handles** of any kind. An **aesthetical, practical and economical advantage** that is certainly unrivalled.



Per armadi a 2 e 3 ante
Un design unico che vi lascerà senza fiato

Grazie al suo particolare **design a cassonetto**, è possibile realizzare sistemi a 2 e 3 ante **senza la necessità di aggiungere e utilizzare maniglie** di alcun tipo. Un **vantaggio estetico, pratico ed economico** decisamente impareggiabile.



Modern and Versatile

Compatible with our sliding systems

Fine can be combined with **our main sliding systems for wardrobes:** Star Fluid, Comfort, which **can be easily installed** in the upper horizontal crossbeams, **thanks to self-drilling screws.**

Lower guides, for doors 17mm or 35mm above the floor, can be easily installed through the **plates positioned on the frame's lower horizontal crossbeams.**

The 28 mm / 40 mm frame is compatible with all the wardrobe sliding systems already in our catalogue. This **great advantage** makes the **system incredibly flexible.**

Moderno e Versatile

Compatibile con i nostri sistemi scorrevoli

Fine si abbina ai **nostri principali sistemi scorrevoli per armadi:** Star Fluid, Comfort, i quali **possono essere facilmente installati** nel traverso orizzontale superiore, **grazie a viti autopercoranti.**

Le guide inferiori, per ante da 17 mm o 35 mm di luce da terra, si installano liberamente grazie alle **piastre posizionate sul traverso orizzontale inferiore** del telaio.

Il telaio con spessore da 28 mm o da 40 mm è compatibile con tutti i sistemi scorrevoli per armadi già presenti nel nostro catalogo. Un **grande vantaggio** che rende il **sistema estremamente flessibile.**



Oxidised and painted finishes

For modern settings

Fine is available in the **standard finishes** we offer and in oxidised and painted finishes such as: **Metal Grey, Graphite and White (RAL 9002)**.

Finiture ossidate e verniciate

Per ambienti moderni

Fine è disponibile nelle **finiture standard** da noi fornite sia ossidate che verniciate come: **Metal Grey, Grafite e Bianco (RAL 9002)**.



With a **single sliding system kit**, it's also possible to combine a glass and a wooden door - **yet another aesthetic and technical advantage**.

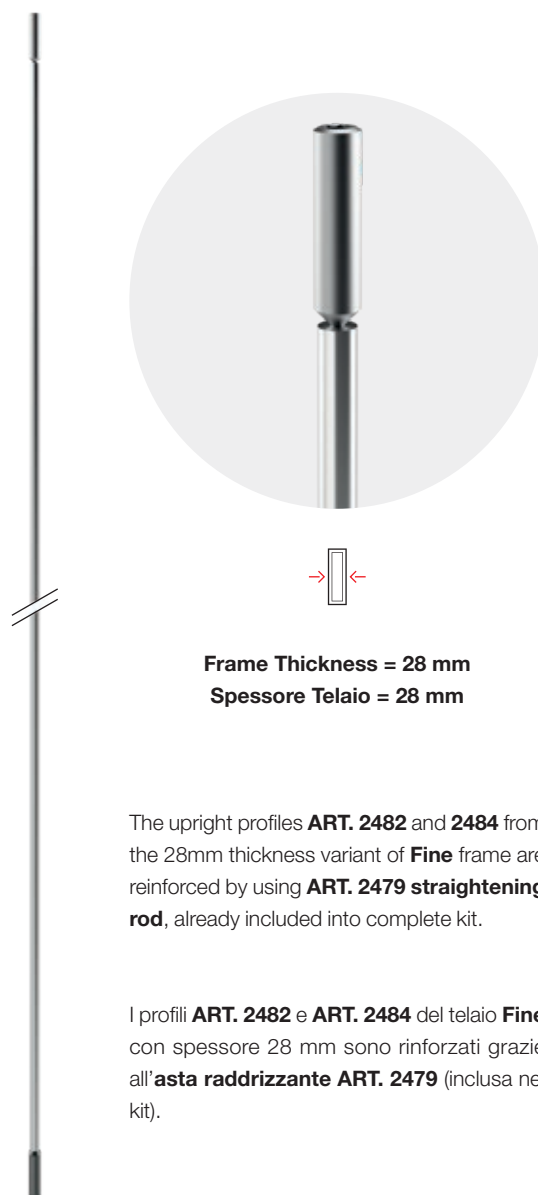

È inoltre possibile, **con un unico kit di scorrevoli**, abbinare sia un'anta in legno che un'anta in vetro: **un ulteriore vantaggio tecnico ed estetico**.





Frame Thickness = 28 mm
Spessore Telaio = 28 mm

The upright profiles **ART. 2482** and **2484** from the 28mm thickness variant of **Fine** frame are reinforced by using **ART. 2479 straightening rod**, already included into complete kit.

I profili **ART. 2482** e **ART. 2484** del telaio **Fine** con spessore 28 mm sono rinforzati grazie all'**asta raddrizzante ART. 2479** (inclusa nel kit).

| Fine | | COMPLETE BOX KIT / KIT COMPLETO IN SCATOLA | |  |
|-------------|-----------------------------|---|--|---|
| K | Complete kit / Kit completo | | | |
| | 1402 |  | Frame Thickness 28 mm — Wood/Glass Doors 4 mm Spessore Telaio 28 mm — Ante Legno/Vetro 4 mm | |
| | 1403 |  | Frame Thickness 40 mm — Wood/Glass Doors 4 mm Spessore Telaio 40 mm — Ante Legno/Vetro 4 mm | |
| | | 0 | Internal Door — Standard Drilling / Anta Interna — Foratura Standard | |
| | | 1 | External Door — Standard Drilling / Anta Esterna — Foratura Standard | |
| | | | | 01 750 x 2700 mm |
| | | | | 02 1000 x 2700 mm |
| | | | | 03 1400 x 2700 mm |
| | | | | 02 Brushed Anodized Silver / Argento Spazzolato |
| | | | | 15 Brushed Anodized Black / Nero Spazzolato |
| | | | | 17 Brushed Anodized Nickel / Nichel Spazzolato |
| | | | | 28 Metal Grey |
| | | | | 30 Graphite / Grafite |
| | | | | 39 White / Bianco (RAL 9002) |

| Fine | | COMPLETE BLISTER KIT / KIT COMPLETO IN BLISTER | |  |
|-------------|-----------------------------|---|---|---|
| B | Complete kit / Kit completo | | | |
| | 1400 | Crossbeam Accessories Accessori Trasverso | | |
| | | 0 |  | Frame Thickness 28 mm Spessore Telaio 28 mm |
| | | 1 |  | Frame Thickness 40 mm Spessore Telaio 40 mm |
| | | | | 01 750 mm |
| | | | | 02 1000 mm |
| | | | | 03 1400 mm |
| | | | | 04 2700 mm |
| | | | | 02 Brushed Anodized Silver / Argento Spazzolato |
| | | | | 15 Brushed Anodized Black / Nero Spazzolato |
| | | | | 17 Brushed Anodized Nickel / Nichel Spazzolato |
| | | | | 28 Metal Grey |
| | | | | 30 Graphite / Grafite |
| | | | | 39 White / Bianco (RAL 9002) |

| Fine | | COMPLETE ACCESSORIES KIT / KIT ACCESSORI COMPLETI | |
|-------------|-----------------------------|---|---|
| K | Complete kit / Kit completo | | |
| | | 1400 | Door Accessories Accessori per Anta |
| | | | |
| | | | 0 Standard Drilling Foratura Standard |
| | | | |
| | | | 00 Frame joints + Guide fixing plate Giunti per Angolo + Piastre Scorrevoli |
| K | Complete kit / Kit completo | | |
| | | 1401 | Crossbeam Accessories Accessori per Traverso |
| | | | |
| | | | 0 Crossbeam joints Giunti per Traverso |

EXAMPLE / ESEMPIO

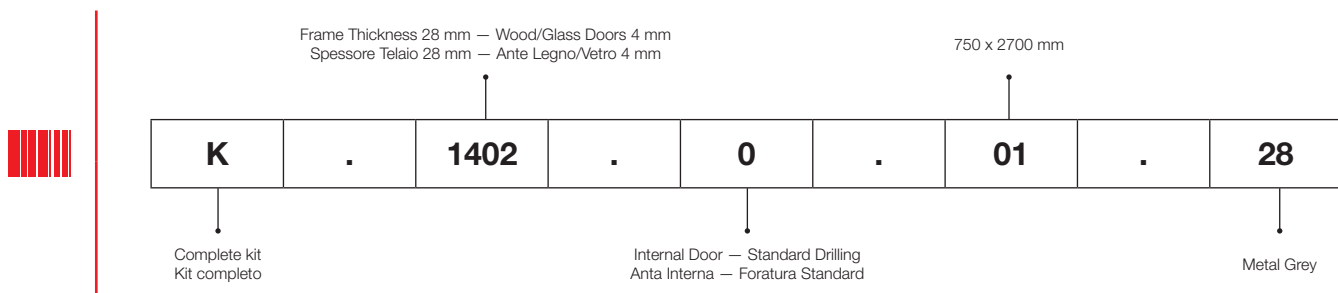

| Tracks / Binari | | ALUMINUM FINISHES CODES / CODICI FINITURE ALLUMINIO | |
|------------------------|--------------------------------|---|--|
| CODE / CODICE | FINISH COLOR / COLORE FINITURA | | |
| 8 02 0.0 | | 02 | Brushed Anodized Silver / Argento Spazzolato |
| 8 15 0.0 | | 15 | Brushed Anodized Black / Nero Spazzolato |
| 8 17 0.0 | | 17 | Brushed Anodized Nickel / Nichel Spazzolato |
| 8 28 0.0 | | 28 | Metal Grey |
| 8 30 0.0 | | 30 | Graphite / Grafite |
| 8 39 0.0 | | 39 | White / Bianco (RAL 9002) |
| | | | STANDARD |
| | | | SPECIAL |

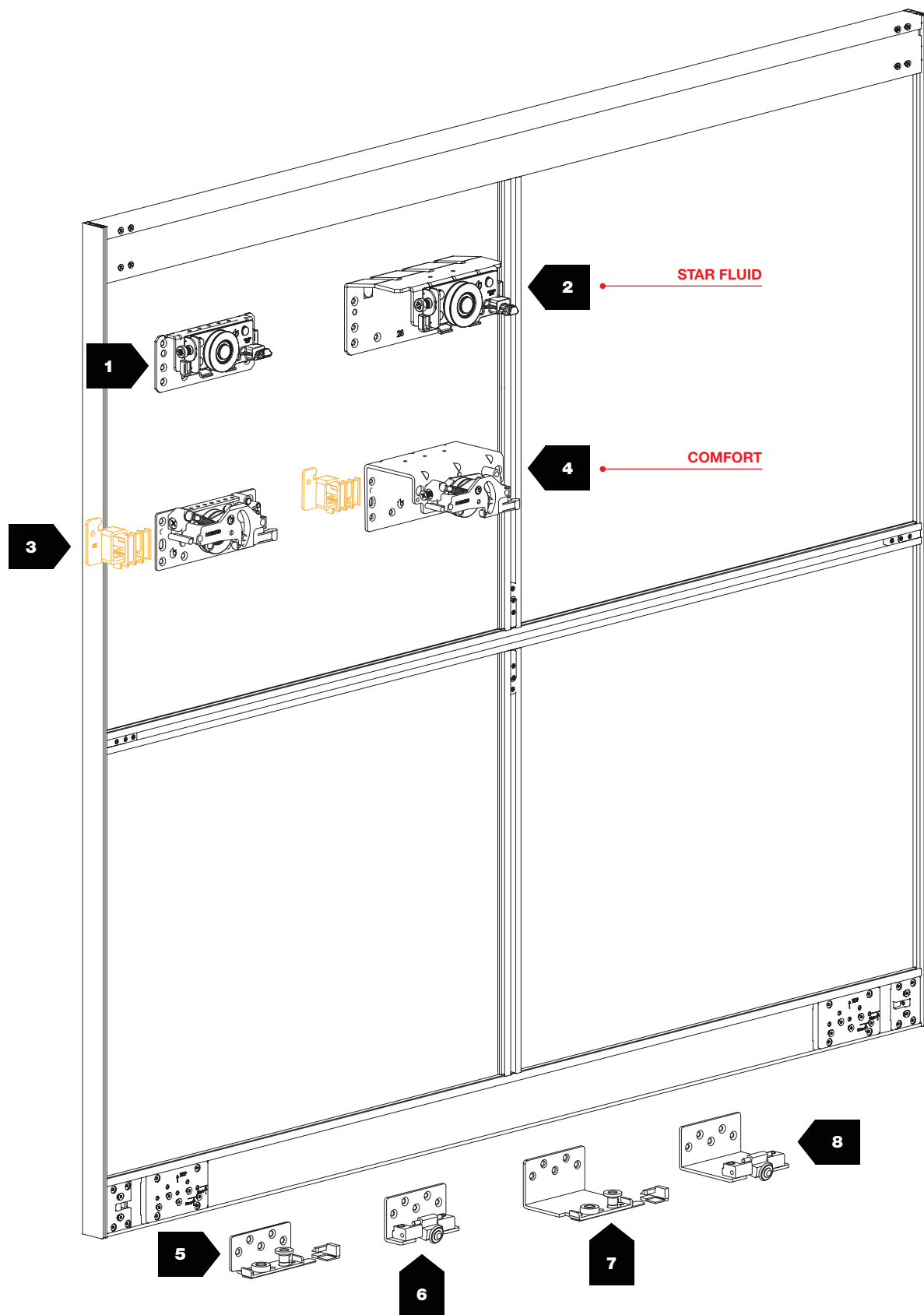

28 ÷ 40 mm

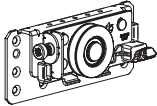
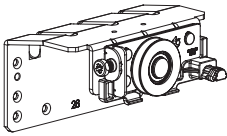
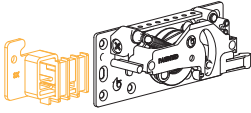
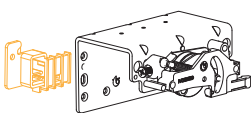

17 ÷ 35 mm

| N° | | | kg | | N° | | kg | | |
|----|------|---|----|----------------------------------|----|--------|----|----------------------------------|-------------------------------|
| 1 | 3062 |  | — | Slides Scorrevoli 28÷40 mm | 5 | 582 | — | Slides Scorrevoli 28÷40 mm | |
| 2 | 3074 |  | — | Slides Scorrevoli 28 mm | 6 | 1902/N | — | Slides Scorrevoli 28÷40 mm | |
| | 3075 | | | Slides Scorrevoli 30 mm | | | | | |
| | 3077 | | | Slides Scorrevoli 40 mm | | | | | |
| 3 | 2961 |  | — | Slides Scorrevoli 28÷40 mm | 7 | 586 | — | Slides Scorrevoli 28 mm | |
| | | | | | | | | 499 | Slides Scorrevoli 30 mm |
| | | | | | | | | | 597 |
| 4 | 2966 |  | — | Slides Scorrevoli 28 mm | 8 | 1906/N | — | Slides Scorrevoli 28 mm | |
| | 2967 | | | Slides Scorrevoli 30 mm | | | | | |
| | 2969 | | | Slides Scorrevoli 40 mm | | | | | |
| | | | | | | 1903/N | — | Slides Scorrevoli 30 mm | |
| | | | | | | 1905/N | — | Slides Scorrevoli 40 mm | |

Fine

The new aluminium frame for sliding doors
Il nuovo telaio in alluminio per ante scorrevoli

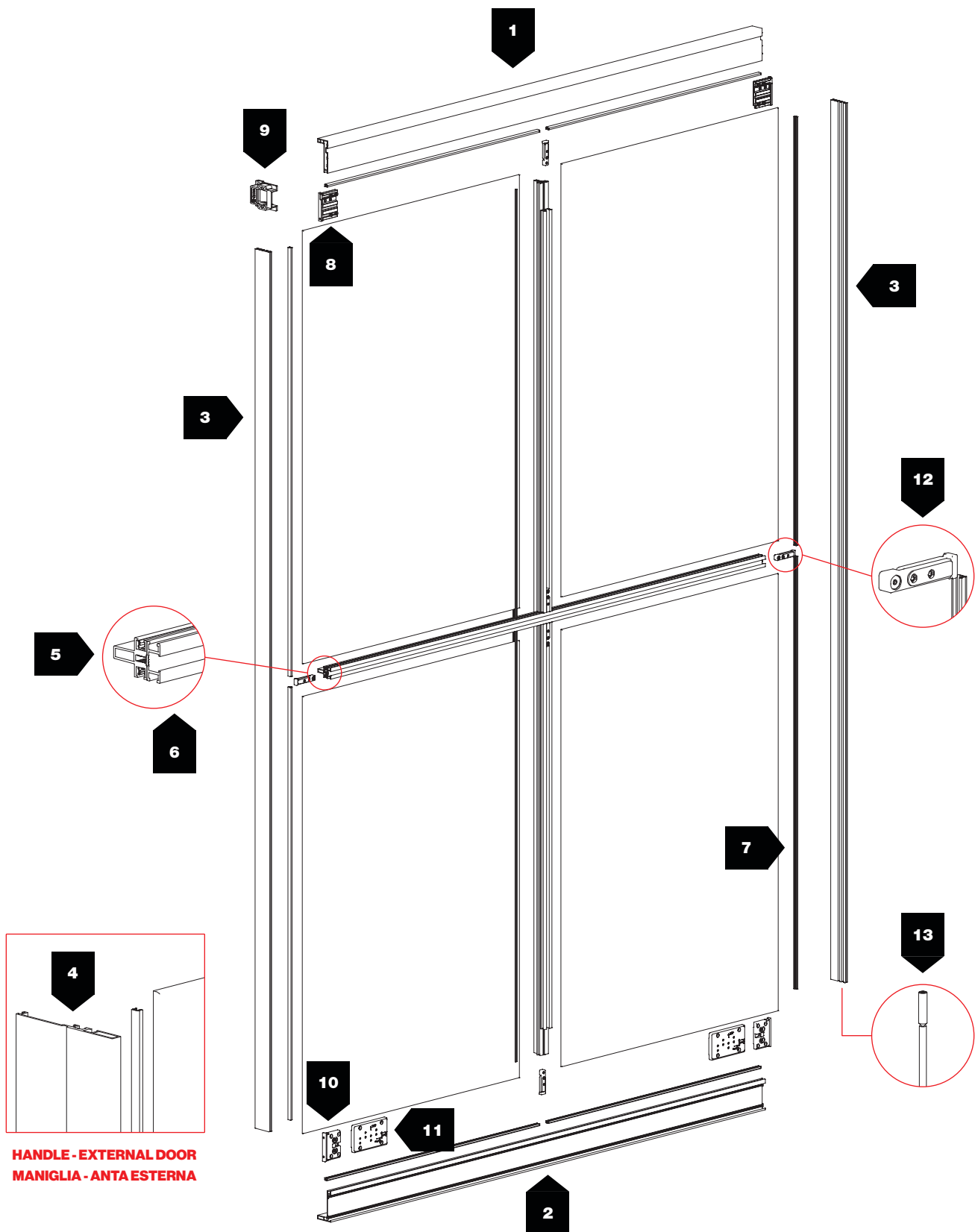

28 ÷ 40 mm







17 ÷ 35 mm

| N° | Barcode | Image | kg | Dimensions | N° | Barcode | Image | kg | Dimensions |
|----|---------|-------|----|------------------------|----|---------|-------|------|------------------------|
| 1 | 2477 | | — | Frames Telaio 28÷30 mm | 6 | 2475 | | — | Frames Telaio 28÷40 mm |
| | 2468 | | — | Frames Telaio 40 mm | 7 | 2476 | | — | Frames Telaio 28÷40 mm |
| 2 | 2481 | | — | Frames Telaio 28÷30 mm | 8 | 2457 | | — | Frames Telaio 28÷40 mm |
| | 2471 | | — | Frames Telaio 40 mm | | | 9 | 2455 | |
| 3 | 2482 | | — | Frames Telaio 28÷30 mm | 10 | 2462 | | — | Frames Telaio 28÷40 mm |
| | 2472 | | — | Frames Telaio 40 mm | | | 11 | 2464 | |
| 4 | 2484 | | — | Frames Telaio 28 mm | 12 | 2463 | | — | Frames Telaio 28÷40 mm |
| | 2474 | | — | Frames Telaio 40 mm | | | 13 | 2479 | |
| 5 | 2483 | | — | Frames Telaio 28÷30 mm | | | | | |
| | 2473 | | — | Frames Telaio 40 mm | | | | | |

Fine

The new aluminium frame for sliding doors
Il nuovo telaio in alluminio per ante scorrevoli

-  Kit for N.1 door
Kit per N.1 anta
-  Internal Door (2 doors)
Anta Interna (2 ante)
-  Internal/External Door (3 doors)
Anta Interna/Esterna (3 ante)
-  Standard Drilling
Foratura Standard

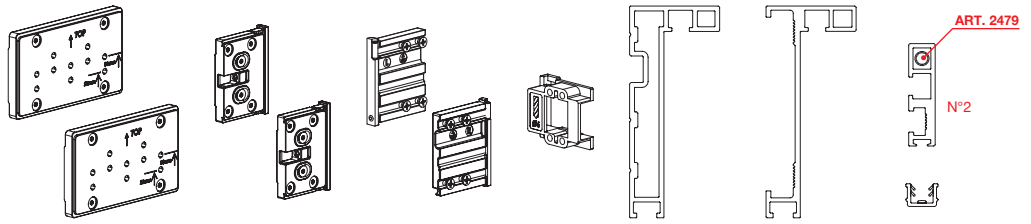



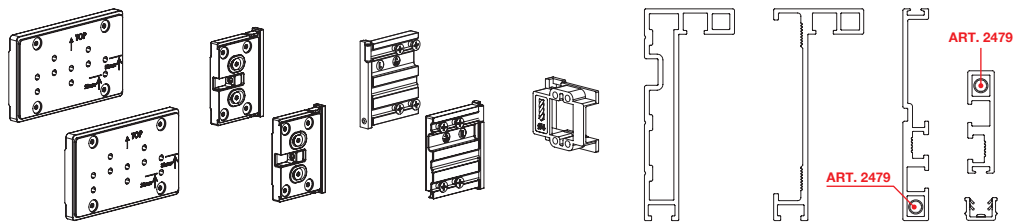

| CODE | FINISHES / FINITURE |  | SIZE / DIMENSIONI |
|-------------|-----------------------------------|---|-------------------|
| K.1402.0.01 | .02 .15 .17 .28 .30 .39 | 28 mm | 750 x 2700 mm |
| K.1402.0.02 | .02 .15 .17 .28 .30 .39 | | 1000 x 2700 mm |
| K.1402.0.03 | .02 .15 .17 .28 .30 .39 | | 1400 x 2700 mm |

-  Kit for N.1 door
Kit per N.1 anta
-  External Door
Anta Esterna
-  Standard Drilling
Foratura Standard



| CODE | FINISHES / FINITURE |  | SIZE / DIMENSIONI |
|-------------|-----------------------------------|---|-------------------|
| K.1402.1.01 | .02 .15 .17 .28 .30 .39 | 28 mm | 750 x 2700 mm |
| K.1402.1.02 | .02 .15 .17 .28 .30 .39 | | 1000 x 2700 mm |
| K.1402.1.03 | .02 .15 .17 .28 .30 .39 | | 1400 x 2700 mm |

-  Kit for N.1 door
Kit per N.1 anta
-  Internal Door (2 doors)
Anta Interna (2 ante)
-  Internal/External Door (3 doors)
Anta Interna/Esterna (3 ante)
-  Standard Drilling
Foratura Standard

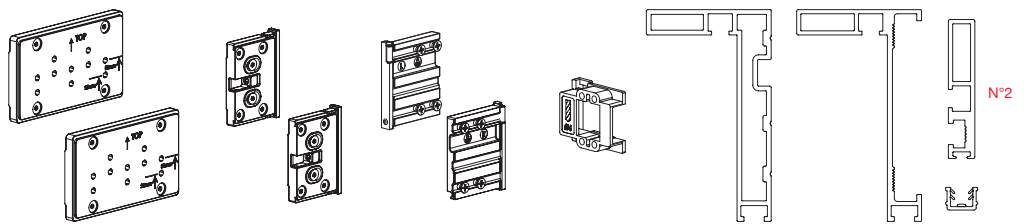

| CODE | FINISHES / FINITURE |  | SIZE / DIMENSIONI |
|-------------|-----------------------------------|---|-------------------|
| K.1403.0.01 | .02 .15 .17 .28 .30 .39 | 40 mm | 750 x 2700 mm |
| K.1403.0.02 | .02 .15 .17 .28 .30 .39 | | 1000 x 2700 mm |
| K.1403.0.03 | .02 .15 .17 .28 .30 .39 | | 1400 x 2700 mm |

-  Kit for N.1 door
Kit per N.1 anta
-  External Door
Anta Esterna
-  Standard Drilling
Foratura Standard

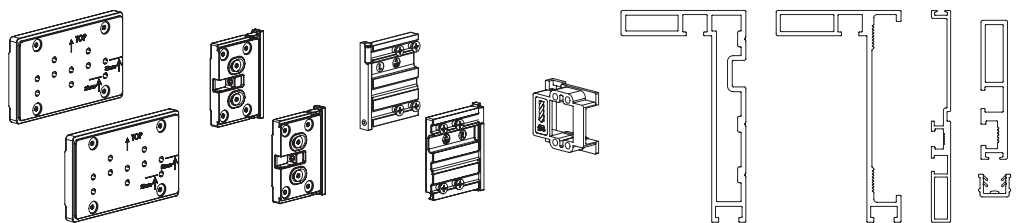

| CODE | FINISHES / FINITURE |  | SIZE / DIMENSIONI |
|-------------|-----------------------------------|---|-------------------|
| K.1403.1.01 | .02 .15 .17 .28 .30 .39 | 40 mm | 750 x 2700 mm |
| K.1403.1.02 | .02 .15 .17 .28 .30 .39 | | 1000 x 2700 mm |
| K.1403.1.03 | .02 .15 .17 .28 .30 .39 | | 1400 x 2700 mm |

| FINISHES / FINITURE | FINISHES / FINITURE | FINISHES / FINITURE | FINISHES / FINITURE | FINISHES / FINITURE | FINISHES / FINITURE |
|--|--|---|-----------------------|--------------------------------|--|
| .02 Brushed Anodized Silver Argento Spazzolato | .15 Brushed Anodized Black Nero Spazzolato | .17 Brushed Anodized Nickel Nichel Spazzolato | .28 Metal Grey | .30 Graphite Grafite | .39 White (RAL 9002) Bianco (RAL 9002) |

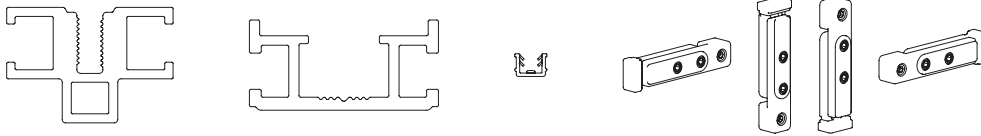

 Crossbeam Accessories
Accessori Traverso

| CODE | FINISHES / FINITURE |  | SIZE / DIMENSIONI |
|-------------|-----------------------------------|---|-------------------|
| B.1400.0.01 | .02 .15 .17 .28 .30 .39 | 28 mm | 750 mm |
| B.1400.0.02 | .02 .15 .17 .28 .30 .39 | | 1000 mm |
| B.1400.0.03 | .02 .15 .17 .28 .30 .39 | | 1400 mm |
| B.1400.0.04 | .02 .15 .17 .28 .30 .39 | | 2700 mm |

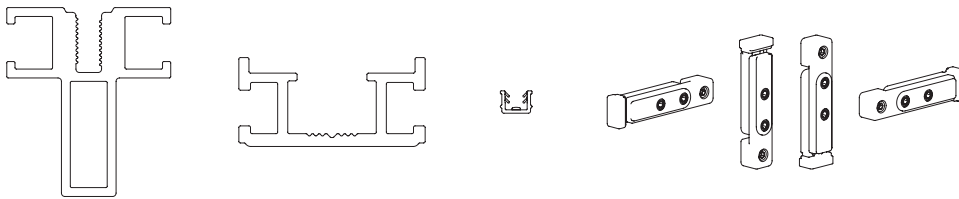

 Crossbeam Accessories
Accessori Traverso

| CODE | FINISHES / FINITURE |  | SIZE / DIMENSIONI |
|-------------|-----------------------------------|---|-------------------|
| B.1400.1.01 | .02 .15 .17 .28 .30 .39 | 40 mm | 750 mm |
| B.1400.1.02 | .02 .15 .17 .28 .30 .39 | | 1000 mm |
| B.1400.1.03 | .02 .15 .17 .28 .30 .39 | | 1400 mm |
| B.1400.1.04 | .02 .15 .17 .28 .30 .39 | | 2700 mm |

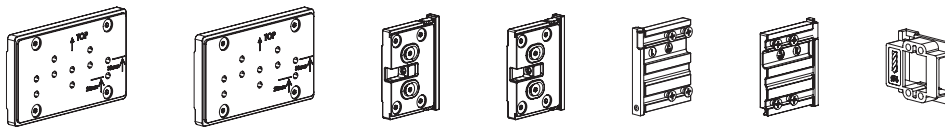

 Door Accessories
Accessori Anta

| CODE |  |
|-------------|---|
| K.1400.0.00 | 28 ÷ 40 mm |

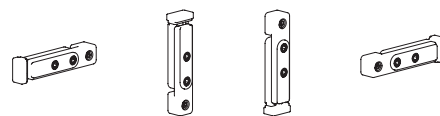

 Crossbeam Accessories
Accessori Traverso

| CODE |  |
|----------|---|
| K.1401.0 | 28 ÷ 40 mm |

| FINISHES / FINITURE | .02 | .15 | .17 | .28 | .30 | .39 |
|---------------------|---|---|--|------------|---------------------|---------------------------------------|
| | Brushed Anodized Silver Argento Spazzolato | Brushed Anodized Black Nero Spazzolato | Brushed Anodized Nickel Nichel Spazzolato | Metal Grey | Graphite Grafite | White (RAL 9002) Bianco (RAL 9002) |

MEASUREMENTS DESCRIPTION / DESCRIZIONE MISURE

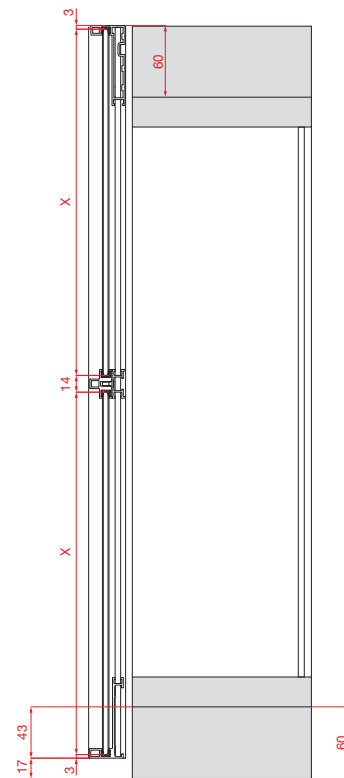
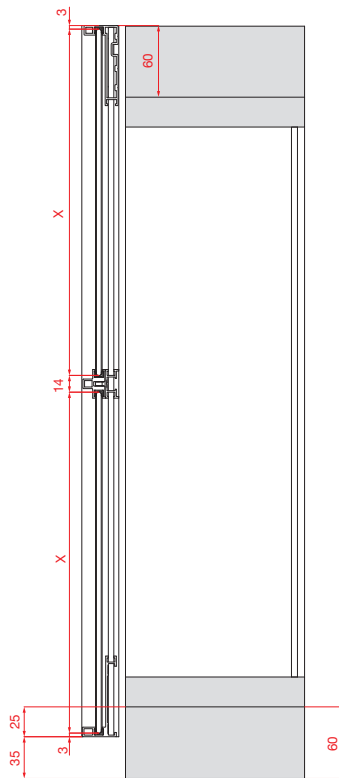

MEASUREMENTS DESCRIPTION / DESCRIZIONE MISURE

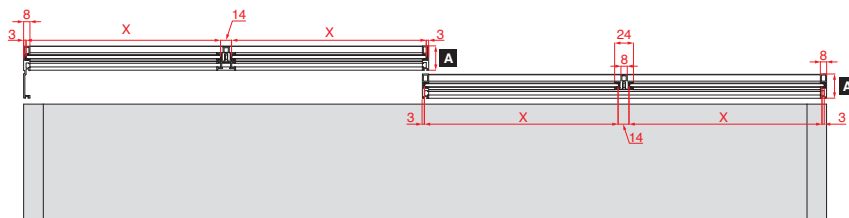
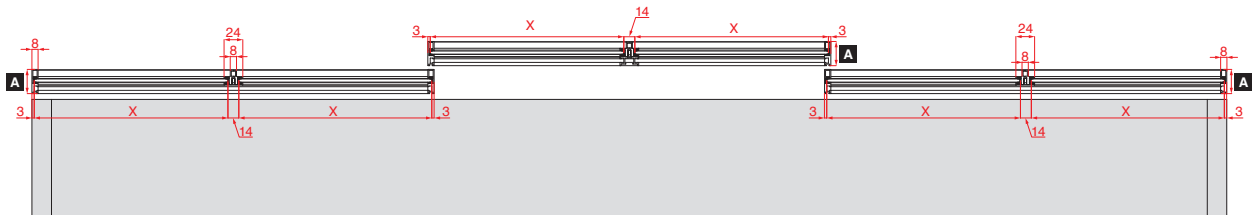

28 mm

A = 31



40 mm

A = 42

MEASUREMENTS DESCRIPTION / DESCRIZIONE MISURE

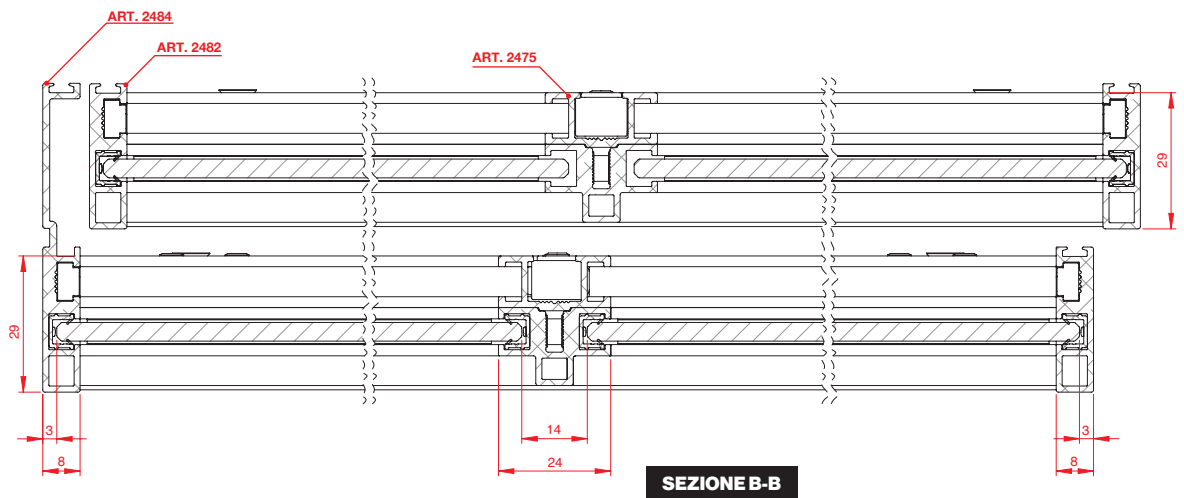
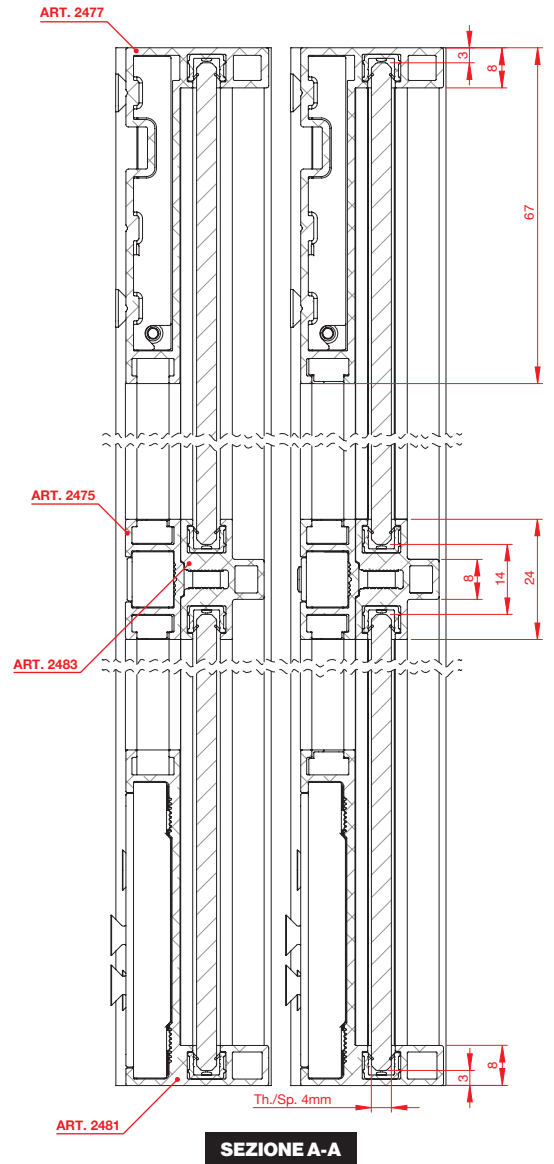
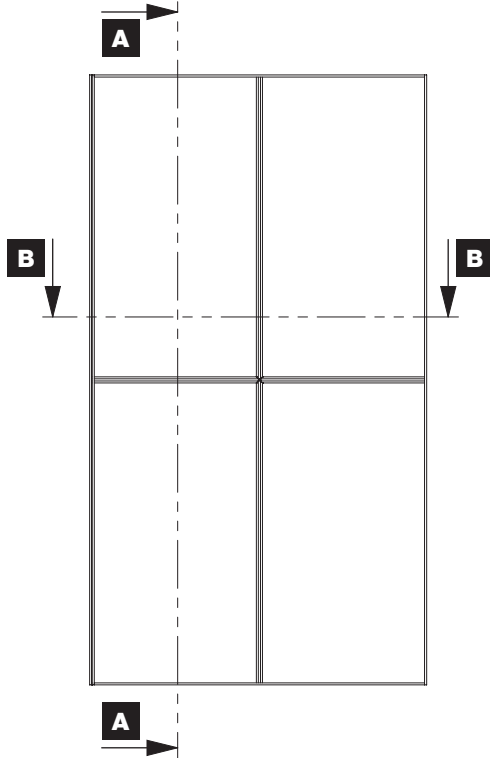

FRAME THICKNESS 28 mm / SPESSORE TELAIO 28 mm

MEASUREMENTS DESCRIPTION / DESCRIZIONE MISURE

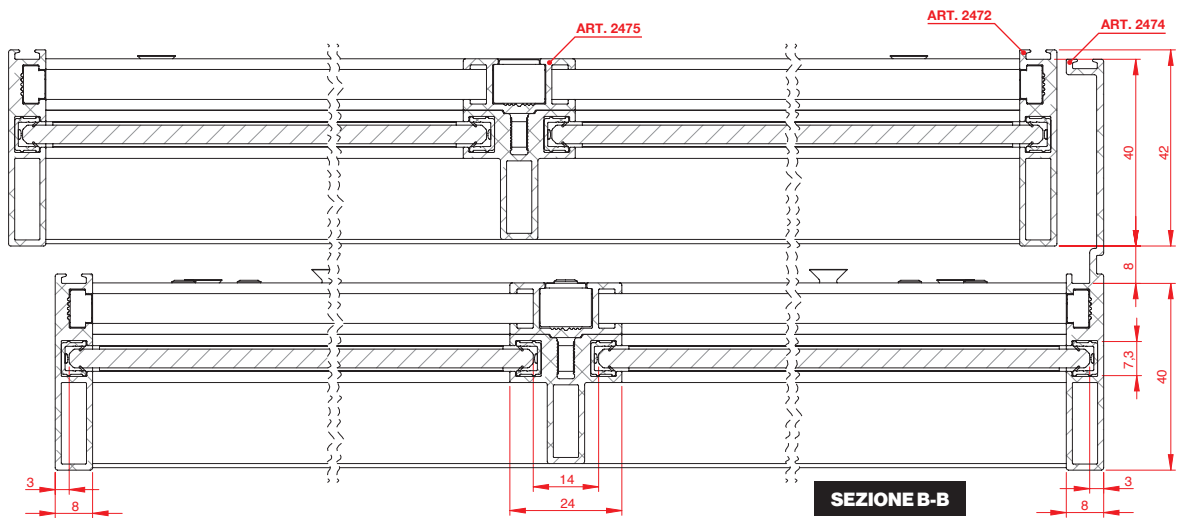
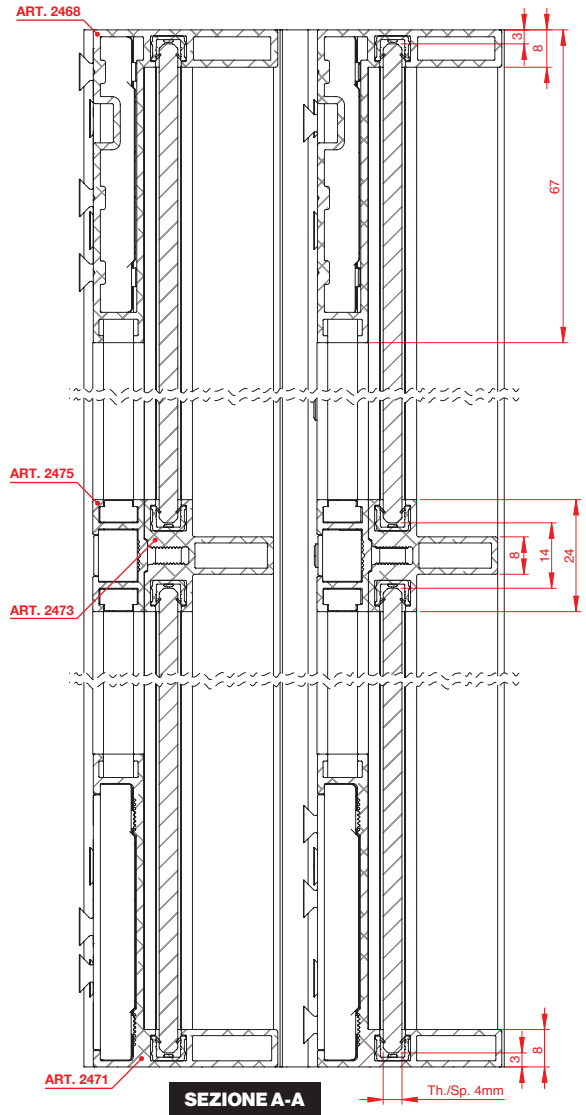
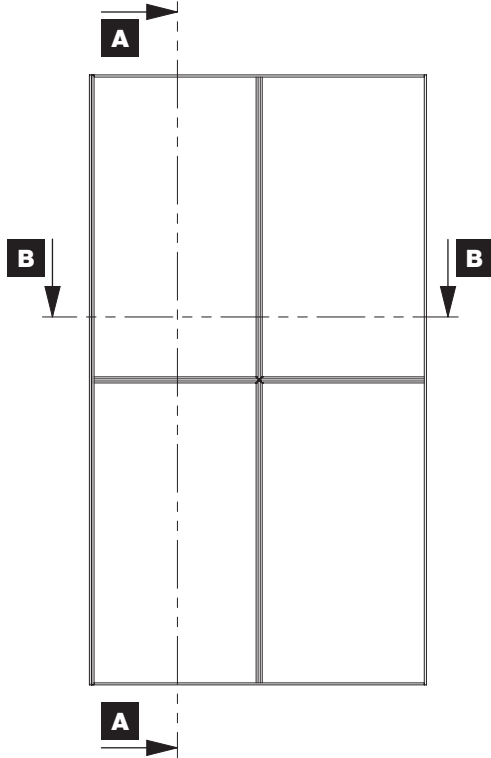

FRAME THICKNESS 40 mm / SPESSORE TELAIO 40 mm



Terno Scorrevoli S.p.A.

**Via Ravenna, 4 - 20814 Varedo (MB) ITALY
Phone +39 0362 543001 - Fax +39 0362 582290**

**terno@ternoscorrevoli.com
www.ternoscorrevoli.com**