

# PROFIL LED CORNER10 BC/UX 2000 ANOD.







Katowe



Meblowe



max 10 mm

	<ul style="list-style-type: none"> <li>• dwa kąty świecenia: 30° i 60°</li> <li>• ukryte mocowanie</li> <li>• szeroki wybór akcesoriów, 7 rodzajów kloszy</li> </ul>	 CE  Wzory przemysłowe EU  Wyprodukowane w Polsce	 Kup produkt
---	--	--	--

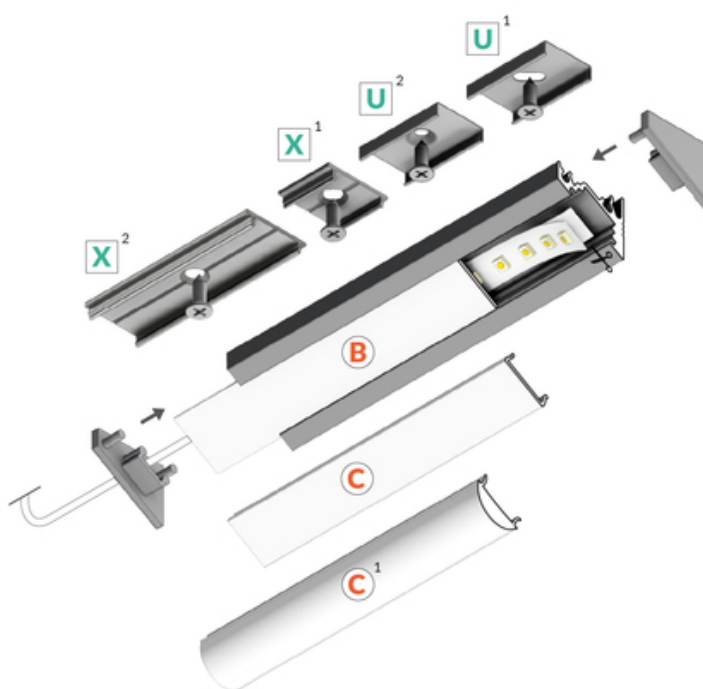
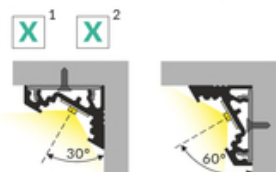
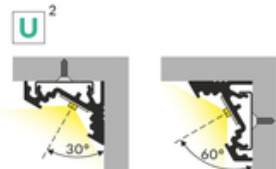
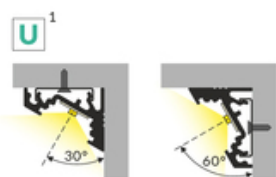
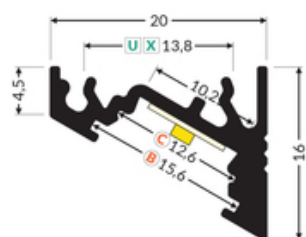

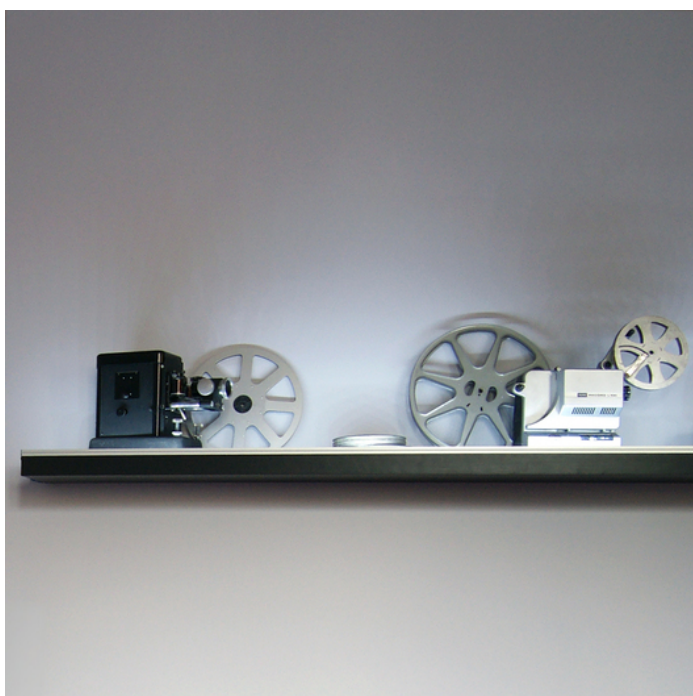

## Informacje podstawowe

Indeks: 83050020 EAN: 5901597201144 Materiał: aluminium Kolor: anodowany Długość [mm]: 2000 Szerokość [mm]: 20 Wysokość [mm]: 16 Waga [kg]: 0.388 Producent: TOPMET Kraj pochodzenia, wytworzenia: PL	Jednostka miary: szt. Wymiary opakowania jednostkowego [mm]: 2000 x 20 x 16 Opakowanie zbiorcze [szt]: 40 Typ opakowania zbiorczego: pakiet Waga produktu z opakowaniem zbiorczym [kg]: 15.52
--	---

## DOSTĘPNE KOLORY



## DOSTĘPNE WARIANTY

1000 mm, 2000 mm, 3000 mm, 4050 mm

## Dopasowane elementy

### KLOSZE DO PROFILI LED



## ZAŚLEPKI DO PROFILI LED



**(EOL) zaślepka  
CORNER10 szary [20szt]**  
index: 83150022



**(EOL) zaślepka  
CORNER10 srebro  
[20szt]**  
index: 83150040



**zaślepka CORNER10  
gen2 szary [20szt]**  
index: 83990022



**zaślepka CORNER10  
gen2 srebro [20szt]**  
index: 83990040



**zaślepka CORNER10  
gen2 z otworem szary  
[20szt]**  
index: 83980022



**zaślepka CORNER10  
gen2 z otworem srebro  
[20szt]**  
index: 83980040

## ŁĄCZNIKI DO PROFILI LED



**łącznik CORNER10 90st  
anod. /op**  
index: 83110020



**łącznik X 180st [1szt]**  
index: 76350000

## UCHWYTY DO PROFILI LED



**uchwyt U cone inox  
[20szt]**  
index: 76620000

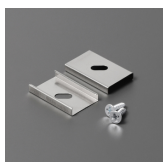

**uchwyt U inox [20szt]**  
index: 76380000

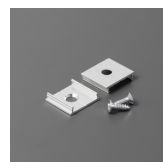

**uchwyt X [20szt]**  
index: 76260000