

# WALLE12 BCD

SPECIAL APPLICATION PROFILE  
PROFIL SPECJALNY

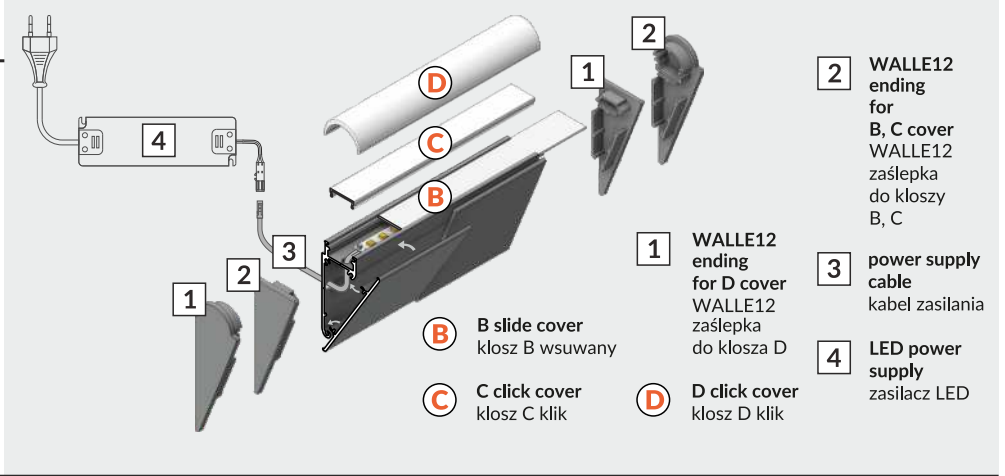

scissors  
nożyczki

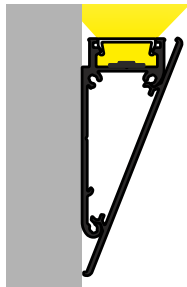
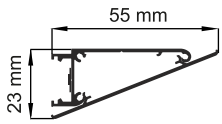

pliers  
kombinerki



soldering iron  
lutownica



solder  
cyna



glue  
klej

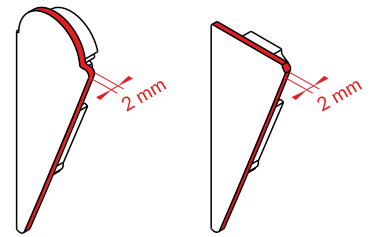
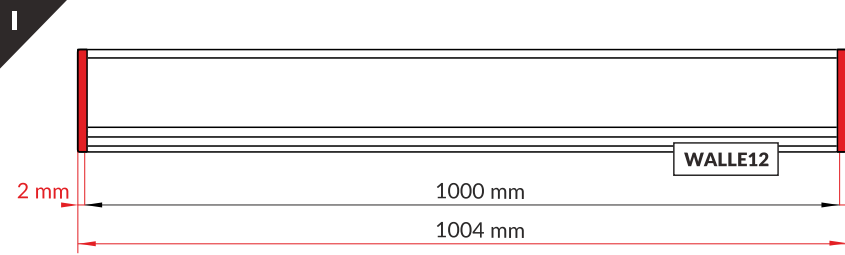

**Note!** Ending thickness increases the length of the luminaires (+ 2 x 2 mm).  
**Uwaga!** Grubość zaślepki zwiększa długość oprawy (+ 2 x 2 mm).

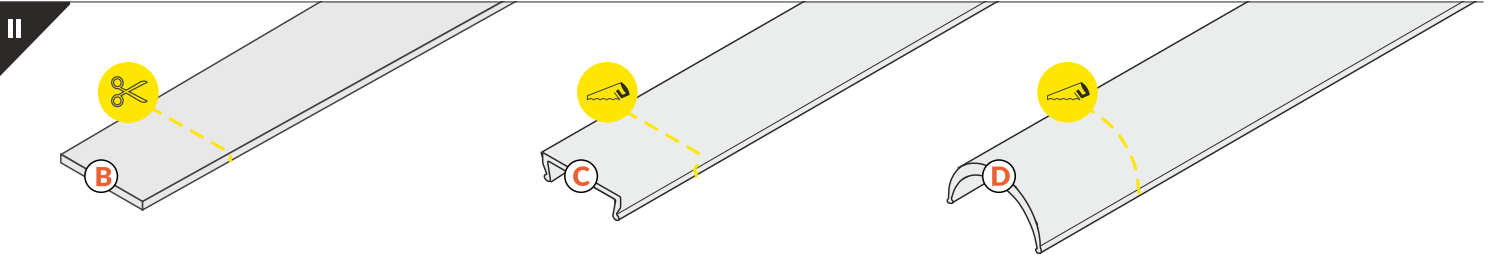

The length of the cover is equal to the length of the profile.  
Długość klosza równa jest długości profilu.

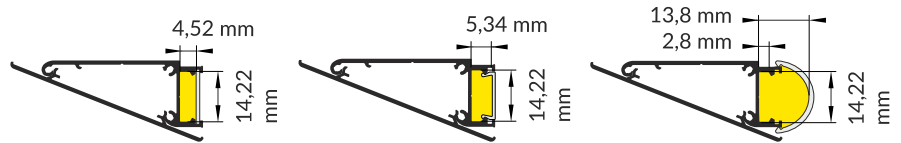
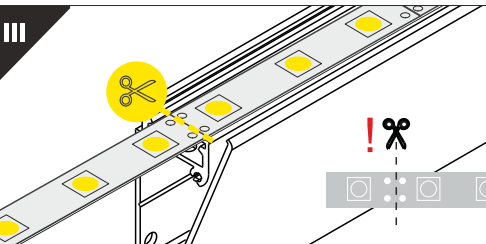

Dimensions of the space to install LED source. / Wymiary przestrzeni do zamontowania źródła LED.

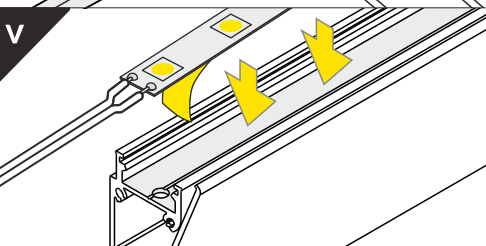
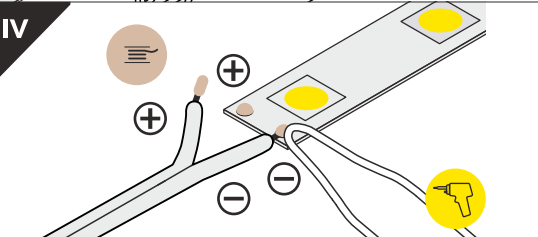

## VI

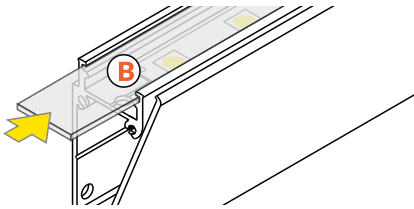

B slide cover / klosz B wsuwany

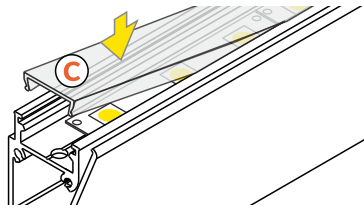

C click cover / klosz C klik

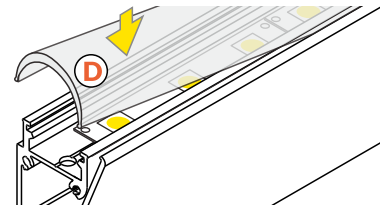

D click cover / klosz D klik

## VII MOUNTING / MONTAŻ

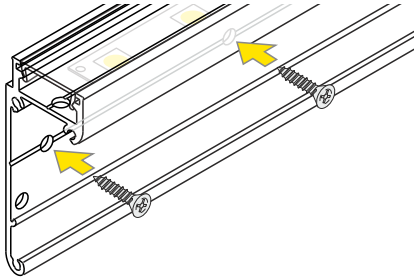

screw  
wkreć

### MOUNTING / MONTAŻ

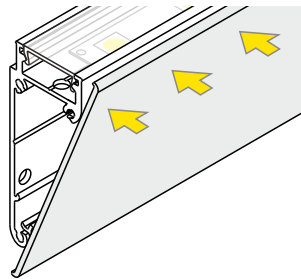
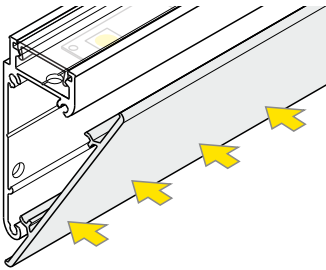

### MOUNTING / DEMONTAŻ

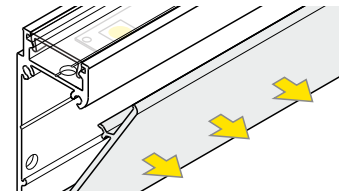
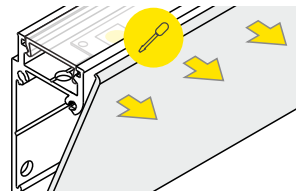

#### NOTE! / UWAGA!

Do not pull the cover by force. A flat tool should be used to remove the cover.

Nie wrywać osłony na siłę.

W celu zdemontowania osłony należy podważyć ją płaskim narzędziem.

## VIII CONNECTORS / ŁĄCZNIKI

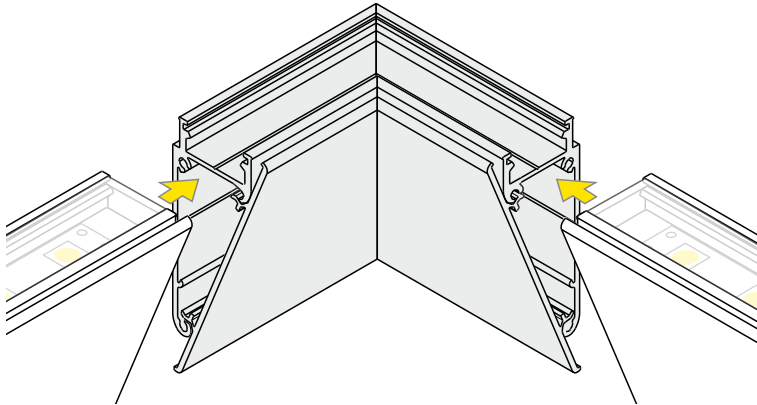

WALLE12 L connector  
WALLE12 łącznik L

WALLE12 X connector  
WALLE12 łącznik kątowy X

## IX POWER SUPPLY / ZASILANIE

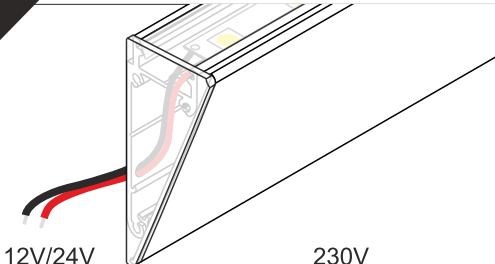

12V/24V

230V

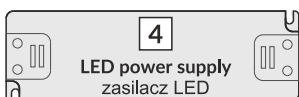

## ACCESSORIES / AKCESORIA

- power switches
- controller + remote
- movement sensors
- włączniki
- sterownik + pilot
- czujniki ruchu

Check the rest - TOPMET catalogue or [www.topmet.co.uk](http://www.topmet.co.uk)  
Zobacz więcej - katalog TOPMET lub [www.topmet.pl](http://www.topmet.pl)



[www.topmet.pl](http://www.topmet.pl)